

IPTV Resource and Performance Management using End-to-End Available Bandwidth Estimation Techniques

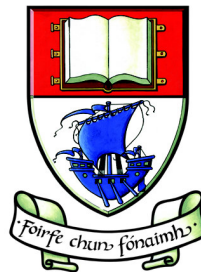

Brian Meskill, BSc

Department of Computing, Mathematics and Physics

Waterford Institute of Technology

Thesis submitted in partial fulfilment of the requirements for the award of

Doctor of Philosophy

Supervisors : Dr Brendan Jennings and Dr Alan Davy

April 2014

Declaration

I hereby certify that this material, which I now submit for assessment on the programme of study leading to the award of Doctor of Philosophy is entirely my own work and has not been taken from the work of others save to the extent that such work has been cited and acknowledged within the text of my work.

Signed:..... ID: 20015271

Date: April 2014

Dedication

To my fiancée, Una

Acknowledgements

I would like to thank my supervisors Dr. Alan Davy and Dr. Brendan Jennings for their continuous help and support which was vital in enabling me to see this thesis through to completion. Their willingness to freely share their knowledge and experience as well as their time provided me with an invaluable amount of guidance when undertaking this research.

I would like to particularly thank Dr. Sasitharan Balasubramaniam, Dr. Ray Carroll and Dr. Leigh Griffin for their help and advice throughout various stages of this PhD. I would further like to thank the research community within the TSSG and the wider Waterford Institute of Technology, especially Dr. Willie Donnelly, Dr. Mícheál Ó Foghlú and Mr. Miguel Ponce de Leon for the opportunities provided to me. I am grateful also to my fellow research students for their continuous support.

I would like to thank most especially my fiancée Una for her unwavering help and encouragement that kept me motivated throughout this research. Furthermore, I would like to remember my father Thomas for the infinite guidance and support he provided and to thank my mother Josephine who continues to do so.

Finally, I would like to sincerely thank my friends who often provided a welcome and necessary distraction along with their encouragement.

Publications

- Meskill, B., Carroll, R., Davy, A., Balasubramaniam, S., & Jennings B., Preferring Data Centres with Renewable Energy Sources when Serving Streaming Video Content, *submitted to Sustainable Computing*, [Meskill et al. \(2015\)](#).
- Meskill, B., Balasubramaniam, S., Brennan, R., Feeney, K., & Jennings B., Federation Lifecycle Management Incorporating Coordination of Bio-inspired Self-management Processes, *Journal of Network and Systems Management (JNSM)*, [Meskill et al. \(2013\)](#).
- Botta, A., Davy, A., Meskill, B. & Aceto, G., Active Techniques for Available Bandwidth Estimation: Comparison and Application, *Data Traffic Monitoring and Analysis* [Botta et al. \(2013\)](#).
- Davy, A., Meskill, B. & Domingo-Pascual, J., An empirical study of effective capacity throughputs in 802.11 wireless networks, *IEEE Global Communications Conference (GLOBECOM)* [Davy et al. \(2012\)](#).
- Meskill, B., Davy, A., & Jennings, B., Revenue-maximizing server selection and admission control for IPTV content servers using available bandwidth estimates, *IEEE Network Operations and Management Symposium (NOMS)* [Meskill et al. \(2012\)](#).
- Meskill, B., Davy, A., & Jennings, B., Server selection and admission control for IP-based video on demand using available bandwidth estimation, *IEEE Local Computer Networks (LCN)* [Meskill et al. \(2011\)](#).

-
- Meskill, B., Davy, A., & Jennings, B., Impact of Topology Complexity on Congestion-based End-to-End Available Bandwidth Estimation Tools. *Tenth Information Technology and Telecommunications (IT&T)*, Meskill *et al.* (2010).

Abstract

Over-The-Top IPTV services have seen a huge increase in popularity in recent years. This fact coupled with the ever increasing resource requirements of IPTV services has created a necessity for efficient and effective management of these IPTV services.

This thesis presents contributions and findings into the use of end-to-end Available Bandwidth estimation to help govern Over-The-Top IPTV service delivery. An examination is presented of the conditions under which end-to-end Available Bandwidth estimation is suitable for use in an IPTV scenario. This work is progressed to show that Available Bandwidth estimation is a suitable basis for Admission Control decisions.

The thesis continues with the presentation and discussion of algorithms that use Available Bandwidth estimation to improve the performance management of the IPTV system. An algorithm is presented that governs the efficient replication of content to allow better use of resources. This is followed by an algorithm that prioritises high value requests with the intention of maximising the revenue generated by an IPTV system.

This thesis also looks at the use of Available Bandwidth estimation when interacting with external business partners. The important area of renewable energy utilisation for IPTV Service Delivery is examined. Available Bandwidth estimation is used in conjunction with energy information at data centres that are in use to ensure both Quality of Service preservation and maximisation of the Green Energy that is used by the IPTV provider. Reactive and predictive approaches to achieve these objectives are both presented.

Contents

Declaration	i
Dedication	ii
Acknowledgements	iii
Publications	iv
Abstract	vi
List of Figures	xi
List of Tables	xiv
List of Algorithms	xv
1 Introduction	1
1.1 Research Hypothesis	3
1.1.1 First Research Question (RQ1)	4
1.1.2 Second Research Question (RQ2)	5
1.1.3 Third Research Question (RQ3)	6
1.2 Main Contributions	6
1.3 Thesis Outline	7
2 Background Information & Literature Review	9
2.1 Background Information	9
2.1.1 Traffic Metrics	10
2.1.1.1 Bandwidth	10
2.1.1.2 Quality of Service	10

2.1.1.3	Quality of Experience	12
2.1.2	Traffic Measurement	12
2.1.2.1	Simple Network Management Protocol	13
2.1.2.2	Remote Network Monitoring	13
2.1.3	Traditional Traffic Management Architectures	14
2.1.3.1	Integrated Services	14
2.1.3.2	Differentiated Services	14
2.1.3.3	Resource Reservation Protocol	14
2.1.4	Internet Protocol TeleVision (IPTV)	15
2.1.4.1	IPTV Standard Codecs	15
2.1.4.2	IPTV Standard Architecture	16
2.2	Literature Review	17
2.2.1	Available Bandwidth Estimation	17
2.2.1.1	PathChirp	18
2.2.1.2	Assolo	19
2.2.1.3	eChirp	19
2.2.1.4	Pathload	19
2.2.1.5	Spruce	20
2.2.1.6	IGI/PTR	20
2.2.1.7	BART and MR-BART	21
2.2.1.8	GNAPP	21
2.2.1.9	Comparisons and Analyses of ABETs	21
2.2.2	Content Distribution Mechanisms	22
2.2.2.1	Content Delivery Networks	22
2.2.2.2	Peer to Peer Delivery	23
2.2.3	Admission Control	23
2.2.3.1	Parameter Based Admission Control	24
2.2.3.2	Measurement Based Admission Control	24
2.2.3.3	Experience Based Admission Control	24
2.2.3.4	Admission Control for IPTV	25
2.2.4	Green Energy in ICT	25
2.3	Summary	27

3	Feasibility of Using ABETs for IPTV Admission Control	28
3.1	Comparison of Available Bandwidth Estimation Tools	29
3.1.1	Experimental Setup	29
3.1.2	Constant Bit Rate Results	32
3.1.2.1	Topology One	32
3.1.2.2	Topology Two	33
3.1.2.3	Topology Three	33
3.1.3	Variable Bit Rate Results	33
3.1.3.1	Topology One	34
3.1.3.2	Topology Two	34
3.1.3.3	Topology Three	34
3.1.4	Influence of Bottleneck Location	35
3.1.4.1	Two hops containing cross traffic.	35
3.1.4.2	Three hops containing cross traffic.	35
3.1.5	Discussion of Experimental Results	36
3.2	Using ABETs in IPTV Server Selection / Admission Control	40
3.2.1	ABAC: Available Bandwidth based Admission Control	45
3.2.2	Algorithms for Comparison	48
3.2.3	Experimental Setup	49
3.2.4	Steady State Network	50
3.2.5	Increased Background Network	53
3.3	Summary	55
4	IPTV Resource and Revenue Management	58
4.1	Content Replication	59
4.1.1	Adaptive Replication Algorithm	59
4.1.2	Experimental Setup	63
4.1.3	Increased Requests Results	66
4.1.4	Increased Background Results	69
4.2	Content Delivery	71
4.2.1	Revenue Maximising Algorithm	73
4.2.2	Experimental Setup	79
4.2.3	Experimental Results and Analysis	80

4.3	Summary	87
5	Use of ABETs in External Business Partner Interactions	89
5.1	The Green Index Metric	90
5.2	Green Index Aware Algorithms	93
5.2.1	Green Index Based Server Selection Algorithm	93
5.2.2	Available Bandwidth & Green Energy Aware Server Selection / Admission Control Algorithm	95
5.2.3	GA-Based Request Allocation	97
5.2.3.1	Micro Genetic Algorithm	97
5.2.3.2	Server Selection	100
5.3	Evaluation	103
5.3.1	Simulation Model	103
5.3.2	Experimental Results Analysis	105
5.3.2.1	Evaluation of ABAC and GIAC	107
5.3.2.2	Evaluation of ABGIAC	111
5.3.2.3	Evaluation of GA	116
5.4	Summary	118
6	Conclusion	120
6.1	Future Work	123
6.1.1	Incorporating Multiple ABETs	123
6.1.2	Federated CDN Service	123
	References	137
	List of Acronyms	140
	A Supplementary Graphs	141

List of Figures

1.1	Intra and Inter Service Provider levels of interaction.	4
2.1	IPTV Reference Architecture.	17
3.1	Experiment topology with one cross traffic flow.	30
3.2	Experiment topology with two cross traffic flows.	31
3.3	Experiment topology with three cross traffic flows.	31
3.4	Packet train arrival times	37
3.5	Topology comparison for CBR traffic using pathChirp.	38
3.6	Topology comparison for CBR traffic using Assolo_MA.	38
3.7	Topology comparison for CBR traffic using eChirp.	39
3.8	Topology comparison for CBR traffic using Assolo_VHF.	39
3.9	End-to-end delay with varying Spread Factor values.	41
3.10	End-to-end delay with varying Inter Estimate Times.	42
3.11	End-to-end delay with varying Moving Average values.	42
3.12	End to End Delay when using ABET based Admission Control with Assolo and pathChirp.	44
3.13	Traffic Flows admitted by ABET based Admission Control using Assolo and pathChirp.	44
3.14	Admission Control Framework Components.	45
3.15	IPTV Admission Control Component Interaction.	46
3.16	IPTV Admission Control Component Interaction.	47
3.17	Server Selection / Admission Control Experimental Topology.	51
3.18	End to End Delay of all AC approaches for Steady State Network. . . .	52
3.19	Requests admitted of all AC approaches for Steady State Network. . . .	52

LIST OF FIGURES

3.20	End to End Delay of all AC approaches for Increased Background Network.	53
3.21	Requests admitted of all AC approaches for Increased Background Network.	54
3.22	Requests admitted by ABAC.	55
3.23	Requests admitted by SBAC.	56
3.24	Loaded path (path C) utilization during ABAC Increased Background. .	56
3.25	Loaded path (path C) utilization during SBAC Increased Background. .	57
4.1	Simplified IPTV Content Distribution Scenario.	60
4.2	Content Replication Experimental Network Topology.	63
4.3	Requests Accepted during a step increase in request arrival rates.	66
4.4	Bandwidth utilisation for adaptive replication during a step increase in request arrival rates.	67
4.5	Server content item class occupancy during a step increase in request arrival rates.	68
4.6	Requests accepted during increased background traffic on paths to two of the three content servers.	69
4.7	Bandwidth utilisation for adaptive replication during increased background traffic.	70
4.8	Server content item class occupancy during a step increase in background traffic.	72
4.9	Experimental Topology Used In REVMAX evaluation.	79
4.10	End to End Delays for the Steady State Network.	81
4.11	End to End Delays for the Increased Background Network.	82
4.12	Requests admitted by ABAC.	83
4.13	Requests admitted by REVMAX.	83
4.14	ABAC Utilization.	85
4.15	REVMAX Utilization.	85
4.16	Comparison of Top Priority Utilizations.	86
4.17	Comparison of Low Priority Utilizations.	86
4.18	Cumulative Total of Top Priority Requests Admitted.	87
5.1	Data-Centre Architecture. Each Data-Centre has varying amounts of “green” and “brown” energy sources.	91

LIST OF FIGURES

5.2	Extended Architecture Component Interaction.	94
5.3	Green Index as calculated at all six datacentres.	104
5.4	Simulation Topology.	105
5.5	Total requests per hour entering the IPTV system.	106
5.6	Requests serviced at California by ABAC.	107
5.7	Bandwidth between each content server and edge router 1 for ABAC.	108
5.8	Requests serviced at each location by GIAC.	108
5.9	Bandwidth between each content server and edge router 1 for GIAC.	109
5.10	Requests experiencing Quality of Service violations for ABAC and GIAC.	110
5.11	Requests Serviced by Green Energy for ABAC and GIAC.	110
5.12	Available Bandwidth between each location and edge router 1 when using ABGIAC.	111
5.13	Requests serviced at all locations for ABGIAC.	112
5.14	Requests serviced using green energy for ABAC, GIAC and ABGIAC.	113
5.15	Number of requests experiencing Quality of Service violations for ABAC, GIAC and ABGIAC.	114
5.16	Total Green Requests for ABGIAC and GA algorithms.	116
5.17	Quality of Service violations for ABGIAC and GA algorithms.	117
5.18	Available Bandwidth levels for all locations using the Genetic Algorithm.	118
6.1	Architecture overview showing the stakeholders potentially involved in service delivery and their distribution across the Internet.	124
6.2	Replication process between an IPTV service provider and IPTV feder- ation partners.	125
6.3	Admission Control process between IPTV users and IPTV federation partners.	126
A.1	Requests serviced at California by ABAC.	142
A.2	Requests serviced at Florida by ABAC.	142
A.3	Requests serviced at Minnesota by ABAC.	143
A.4	Requests serviced at New York by ABAC.	143
A.5	Requests serviced at Texas by ABAC.	144
A.6	Requests serviced at Washington by ABAC.	144

List of Tables

1.1	Research Contributions.	7
3.1	One Hop CBR Error Results.	32
3.2	Two Hop CBR Error Results.	33
3.3	Three Hop CBR Error Results.	33
3.4	One Hop VBR Error Results.	34
3.5	Two Hop VBR Error Results.	34
3.6	Three Hop VBR Error Results.	35
3.7	Accuracy in topology with two hops cross traffic.	36
3.8	All scenario variations for three hops containing cross traffic.	36
3.9	Notation used for ABAC algorithm.	47
4.1	Notation for Adaptive Content Replication Algorithm.	61
4.2	Link Available Bandwidths.	63
4.3	Notation for Randomly Selected Content Replication Algorithm.	64
4.4	Link Available Bandwidths for Increased Background Traffic Scenario.	71
4.5	Notation for REVMAX Admission Control Algorithm.	73
4.6	Content Priorities and Characteristics.	80
4.7	Summary of Revenue Generated.	84
5.1	Notation for GIAC, ABGIAC and GA Admission Control Algorithms.	96
5.2	Data Centre Characteristics.	103

List of Algorithms

1	Algorithm for Available Bandwidth based Admission Control (ABAC).	49
2	Algorithm for Random Server Selection (RAND).	49
3	Algorithm for Admission Control using Static Total Bandwidth (SBAC).	50
4	Adaptive Content Replication Algorithm	62
5	Randomly Selected Content Replication Algorithm	65
6	Revenue maximizing selection / admission control algorithm	77
6	Revenue maximizing selection / admission control algorithm (continued)	78
7	Green Index based server selection algorithm	95
8	ABGIAC based server selection / admission control algorithm	98
9	Genetic Algorithm - Request Optimisation	101
9	Genetic Algorithm - Request Optimisation (continued)	102

Chapter 1

Introduction

In recent years, there has been a consistent significant increase in multimedia services such as Voice over IP (VoIP), Internet based radio, and Internet Protocol TeleVision (IPTV) that are delivered via the Internet. While some of these services are free to the user and others charge for content, they all continue to grow in popularity. This results in an increasingly complex task being placed on the multimedia service provider to deliver the required content in a manner that ensures an acceptable quality. It is also becoming increasingly beneficial for any service provider to optimise the use of their resources to ensure both costs are minimised and revenues are maximised.

As mentioned, IPTV is one such service and the one that has experienced the largest levels of growth and expansion¹. IPTV constitutes both Video on Demand (VoD) and live streaming. VoD is the delivery of stored content when requested by a user (i.e. a film), whereas live streaming is the delivery of live content such as sport or current affairs. Both VoD services and live streaming services have generated significant interest in the research community and have furthermore continued to grow and become popular mainstream services that operate globally to generate very significant revenue, for example, Netflix 2013 and YouTube 2013 for VoD as well as Sky Player 2013 for live streaming. Part of the appeal of these services to end users is the simplicity with which they can be accessed via existing public transit networks, most commonly across the Internet.

¹For example, since its Irish launch alone in January 2012, Netflix has grown to a reported 1 million Irish customers.

Providing these services across networks that are not in the administrative control of the service provider also has significant appeal to the provider. It allows the provider instant access to an almost global customer base as well as significantly reducing the costs (both financial and temporal) of deploying the service. However, this model provides challenges of its own. A service provider will often have network intensive traffic requirements. One of the challenges addressed in this research is to determine if end-to-end Available Bandwidth Estimation can be used to help inform the management decisions that must be made by an IPTV Service Provider. In terms of network management, knowledge of the available bandwidth can provide the service provider with valuable information pertaining to how many more revenue generating flows can be accepted, or on the other hand, how close a provider is to breaking the terms of an existing Service Level Agreement (SLA) that governs the delivery of the video content.

This research undertakes an investigation to determine if end-to-end Available Bandwidth Estimation could be suitable to help inform Admission Control decisions and if so, suggest approaches that leverage this estimation to improve the resource and performance management of the system. As part of such an investigation, it is necessary to examine the feasibility of Available Bandwidth Estimation Tools for use in an IPTV Admission Control scenario.

A logical extension of this is to determine if they can provide benefits and improvements to decision making processes at the business policy level. This research investigates such benefits and improvements. It firstly looks at any such benefits that can be found at an Intra Service Provider level. Algorithms are put forward that use Available Bandwidth estimation to inform methods of resource management and revenue optimisation, enabling superior business policy decisions to be made.

An IPTV service will not be operating without interference and competition for resources from other service providers using the same networks. This is especially true for an IPTV service provider that intends to operate over a network domain that is not within its own control. Therefore, it is prudent to examine what influence can be had by the use of end-to-end Available Bandwidth estimation on Inter Service Provider policies and interactions.

The next section, Section 1.1 presents the formal hypothesis that summates the intent of these investigations as well as the component research questions that explicitly define the scope of this research program.

1.1 Research Hypothesis

The intended contribution of this research is in the area of IPTV service provision. This research intends to investigate whether an end-to-end Available Bandwidth Estimation Tool (ABET) can be used as an input to business policy algorithms¹ and decisions that are used by an IPTV Service Provider. This approach intends to be of benefit to an IPTV Service Provider by positively influencing both the resource and performance management of the system.

It is necessary for this thesis to quantify the envisaged positive influence. To help achieve this, the work in this thesis is divided into research questions. Each question is examined in terms of relevant metrics that are presented in the following sections.

There is two high level components to this intended positive influence on the resource and performance management of the IPTV system. Firstly, there is the intra service provider component which focuses on internal business processes and suggests how available bandwidth estimation can act as an information source in these business policy decisions.

The second component involves an analysis at the inter service provider level (i.e. when the IPTV service provider is interacting with other service providers such as cloud storage providers). This analysis will determine if available bandwidth estimation is an appropriate metric to input into such policies and algorithms.

The intra and inter service provider levels defined here are presented in Figure 1.1 and the hypothesis is formally presented as:

“End-to-End Available Bandwidth Estimation can improve the intra-provider and inter-provider performance of an IPTV Service Provider.”

It is evident that this research contains multiple objectives that can be viewed as complementary but distinct goals. To comprehensively analyse these goals and for the reasons mentioned above, the research is divided into research questions. It is the intention that this research is built up from research question to research question, with the findings of one question being used to inform and improve the research conducted

¹One potential example is an algorithm comparing the cost of breaching a Service Level Agreement to the value of over-subscribing paying customers.

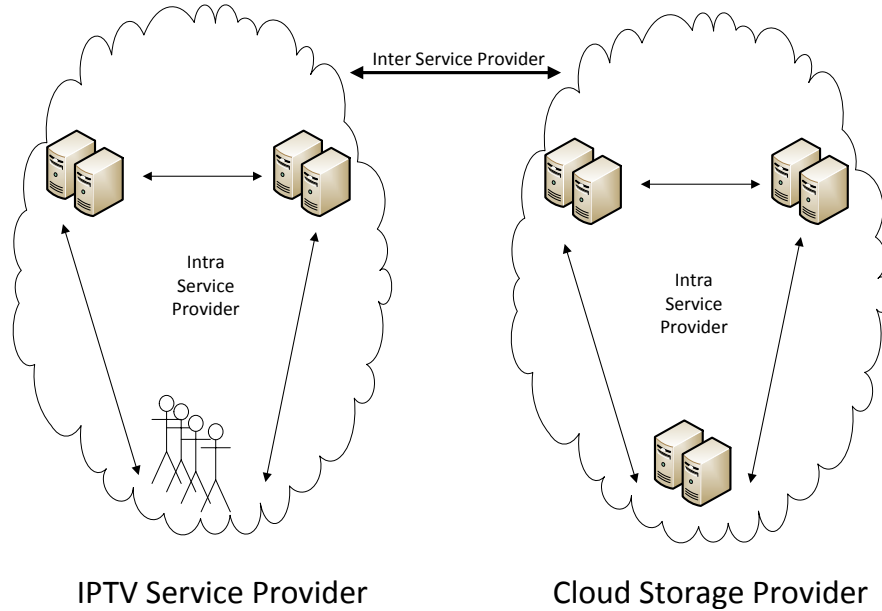

Figure 1.1: Intra and Inter Service Provider levels of interaction.

to address the subsequent questions. The research questions are presented in turn throughout the remainder of this section.

1.1.1 First Research Question (RQ1)

“In what, if any, scenario are end-to-end Available Bandwidth Estimation Tools suitable for use in an IPTV management system?”

The first body of work arising from the stated hypothesis is to examine the performance of existing end-to-end Available Bandwidth estimation tools. There are a couple of factors to consider relating to available bandwidth estimation for this particular scenario. The first of these is to analyse how accurate are available bandwidth tools currently. Whilst accuracy is a necessary and obvious starting point for examining these tools, it will not be sufficient enough on its own for this purpose. It will also be necessary to examine the speed at which these tools can generate estimations along with their suitability while operating in the envisaged scenario of multi-hop network paths that contain multiple links with varying cross traffic.

To fully address this research question, it is necessary to determine a scenario where available bandwidth estimation is of beneficial use to an IPTV service provider. To

this end and having examined the general characteristics of the available bandwidth estimation tools, the specific configuration of such tools which caters for a scenario of using available bandwidth estimates as an input to a server selection / admission control algorithm is examined.

A key metric in judging the benefit of such an algorithm will be by examining the Quality of Service received by accepted requests. Another metric of interest is the ratio of accepted requests to rejections.

1.1.2 Second Research Question (RQ2)

“What benefits or improvements can the use of end-to-end Available Bandwidth estimation provide at an intra Service Provider level?”

The focus in this section is to quantify what improvement can be brought to processes employed by the IPTV Service Provider. This section will examine how content is distributed as well as how content is delivered. The goal is to improve the utilisation of resources available in the system. Indicators of whether this improvement has occurred will include some or all of the following:

- A high level of Quality of Service experienced by requests served in the system.
- An improvement in requests served compared to requests rejected by the system.
- A preservation (in deteriorating network conditions) or improvement (in stable network conditions) of the revenue generated by accepted requests.
- An improvement in the utilisation ratio of servers that operates in respect of requests served and servers in operation.

It is apparent that some of these indicators will increase in tandem if the algorithms and policies proposed are successful, while some will operate as a controlled trade-off. For example, it is possible to envisage a scenario where a slight reduction in requests accepted would mean less servers are required. This would allow the preservation of a higher overall revenue for the IPTV service provider.

1.1.3 Third Research Question (RQ3)

“What benefits or improvements can the use of end-to-end Available Bandwidth estimation provide at an inter Service Provider level?”

As this research is based in a scenario that assumes operation via public, uncontrolled intermediate topologies, it is easy to envisage some form of resource sharing, or business interaction with other service overlays (such as cloud storage providers, for example). This research question will explore the possibilities relating to the use of Available Bandwidth Estimates as current information that enable the IPTV provider to make better policy decisions when creating either short or long term federations with external partners.

Any such federation needs to ensure that the Quality of Service required by accepted requests is adhered to, making this an important metric in evaluating the benefit of such an external interaction. Other metrics that are specific to the purpose of the federation will also need to be analysed to accurately gauge the benefits that are achievable.

1.2 Main Contributions

Throughout the next 3 chapters, each of the presented research questions are dealt with in detail. It is possible to extract and summate the high level contributions that can be taken from these chapters and this is done in the following paragraphs to present the main contributions of this thesis and the research program in general. Table 1.1 maps these contributions to their equivalent research questions and presents the section and page where each contribution is introduced.

- In Chapter 3, it is shown that the accuracy of different end-to-end available bandwidth estimation tools varies, both in a direct comparison and when compared across topologies of varying complexity. It is important therefore, to be cognisant of the intended usage scenario when selecting an ABET for use.
- Chapter 3 further shows that Admission Control and Server Selection that preserves Quality of Service is achievable via the use of some, but not all, end-to-end available bandwidth estimation tools. However, any such tool that is used must be appropriately configured.

Table 1.1: Research Contributions.

RQ1	ABET Comparison	Section 3.1.5, Page 36
RQ1	Available Bandwidth based Admission control	Section 3.2.1, Page 45.
RQ2	Adaptive Content Replication	Section 4.1.1, Page 59
RQ2	Revenue Maximising Content	Section 4.2.1, Page 73.
RQ3	Reactive Green Index aware Admission control	Section 5.2.2, Page 95
RQ3	Predictive Green Index aware Admission control	Section 5.2.3, Page 97.

- In Chapter 4, an algorithm for content distribution is presented that examines the popularity of individual content items and as well as the available bandwidth estimates being returned to improve the usage ratio of content servers that are deployed and active whilst maintaining the Quality of Service of accepted requests.
- Also in Chapter 4, an algorithm is presented that predicts the likelihood of a request of a certain value being received and uses this information along with information about the resources present (i.e. content location and bandwidth availability) to maximise the revenue generated.
- An inline reactive algorithm that couples available bandwidth estimation with green energy information to help a service provider meet their financial and environmental requirements is presented in Chapter 5.
- Furthermore in Chapter 5, an approach to resource planning is presented that provides improved green energy usage whilst still ensuring Quality of Service targets are satisfied.

1.3 Thesis Outline

Chapter 2 firstly presents background information in the general area of telecommunications network management. Following this, a review is conducted of the literature in the areas of contribution of this thesis. The literature review is used as a mechanism to focus the scope of this thesis on research that provides contributions which are

both filling a significant need and distinct whilst being complementary of any benefits provided by existing research.

The focus of Chapter 3 is to address the first research question. A comparison of four available bandwidth estimation tools is presented. This comparison examines the performance of these available bandwidth estimation tools across topologies of various complexity and informs the reader about which tools are suitable for use in an IPTV scenario.

In Chapter 4, algorithms that govern content distribution and content delivery are presented and evaluated. These algorithms address research question two, and focus on the use of available bandwidth estimation at an intra provider level.

Chapter 5 presents an examination of the benefits to the service provider of incorporating Available Bandwidth estimation when interacting with external data centre providers from a perspective of Green Energy utilisation. Two algorithms are presented that show how the percentage of Green Energy that is used can be improved and optimised, without compromising core Quality of Service concerns. The research conducted for this chapter relates back to Research Question three.

Chapter 6 reviews the contributions of the thesis and presents the conclusions from this research programme. Some potential future work is also discussed in this chapter.

Chapter 2

Background Information & Literature Review

This chapter presents the current state of the art for topics that are relevant to over-the-top IPTV service delivery. Section 2.1 provides some context for the research undertaken by presenting historical information and terminology in the general area of traffic and network management. This is achieved by categorising the information presented into the over arching areas of traffic measurement and traffic optimisation. Following this, some background information relating to IPTV is presented.

The chapter continues in Section 2.2 with a review of the published literature in the component areas that this thesis contributes to. A state of the art is presented for the areas of Available Bandwidth (AB) estimation, Content Distribution mechanisms, Admission Control (AC), as well as a review of relevant literature relating to green energy usage in Information and Communications Technology (ICT).

Finally in this chapter, Section 2.3 concludes with a summary.

2.1 Background Information

Traffic Management is a concept that is at the core of telecommunications networks. At its most basic, traffic management is concerned with the timely and/or controlled delivery of content to its intended destination. This can be viewed as being constituted of two components. The first of these components is the measurement of traffic traversing the network. The second component involves the optimisation of the traffic

on the network to match certain targets for each of these measurement metrics. These components are dealt with in turn in the following subsections.

2.1.1 Traffic Metrics

Traffic measurement involves the recording and analysis of statistics about the networks performance. These statistics are gathered in the form of metrics that document the performance of the network over various timescales. The more important of these metrics are presented below.

2.1.1.1 Bandwidth

Bandwidth is a core concept in networking terminology and has been defined as how many bits a network link can transport per second [Tanenbaum & Wetherall \(2011\)](#). Bandwidth is calculated in terms of bits per second (bps). An important metric associated with bandwidth is the Bulk Transfer Capacity (BTC) [Mathis & Allman \(2001\)](#) which defines the maximum transfer capacity between two nodes within a network.

Other related metrics that are frequently of interest include throughput, effective bandwidth and available bandwidth. Throughput is the maximum rate at which none of the offered frames are dropped by the device [Bradner \(1991\)](#) while Effective Bandwidth refers to the minimum amount of bandwidth required by a traffic flow to maintain a specified QoS target [Kelly \(1996\)](#). Available Bandwidth is discussed in more detail in Section [2.2.1](#).

2.1.1.2 Quality of Service

Quality of Service is a term that describes the performance of the following metrics.

Packet Delay or one-way delay refers to the end to end delay experienced by a packet as it traverses a network from sending device to receiving device [Almes *et al.* \(1999a\)](#). It is the overall term to describe the total delay caused by the combination of the delay factors presented below:

- **Propagation Delay** refers to the amount of time a packet takes to traverse between two nodes.

- **Queueing Delay** refers to how long a packet must wait in a queue whilst other packets are being serviced by the node to be traversed.
- **Transmission Delay** is the term describing the amount of time it takes a packet to be serviced at a node, not including queueing delay which is mentioned above.

Another metric relating to packet delay is that of round-trip delay [Almes *et al.* \(1999c\)](#). This is composed of the types of delay mentioned previously but refers to the total combined delay experienced by a packet whilst traveling from source to destination as well as the delay experienced by a packet (such as an acknowledgement) traveling in the opposite direction.

The inclusion of the delay experienced by the second packet in the calculation of round-trip delay is intended to provide a metric that is more useful for interactive applications such as VoIP, for example.

Packet Loss [Almes *et al.* \(1999b\)](#) is a term that refers to a packet that is sent but not successfully received. It is usually referred to by means of the packet loss ratio. This is the amount of packets that are lost by a node or network in any given time period and is usually presented as a percentage of the overall amount of packets sent in the network. Packets can be dropped during network traversal when queue buffers become full, due to heavy congestion in the network.

Packet Jitter [Demichelis & Chimento \(2002\)](#) is the term given to packets arriving at the receiver in sporadic bursts and out of sequence. It is closely related to delay as it is caused by variations in the delay of individual packets in a stream of packets. This can be caused by short term congestion in intermediary nodes or by some packets taking a different route due to route flapping [Ciavattone *et al.* \(2003\)](#).

The values of the above metrics that is considered a good Quality of Service varies significantly between different types of applications. This is due to the fact that the metrics are of differing importance to such applications and based on the characteristics of the application, the relevant metrics are subjected to varying levels of stringency.

This is discussed in detail in [Comer \(2008\)](#) where packet loss is high priority when considering standard web traffic and email traffic whereas bandwidth has a lower priority. When considering IPTV traffic, Comer gives packet loss a lower priority as the focus is on the metrics of delay and jitter.

To ensure these priorities are met, Service Level Agreements (SLAs) are used to set bounds in what is an acceptable level of service. An example of an SLA for an IPTV scenario would be that one-way delay does not exceed 100 milliseconds [Greengrass *et al.* \(2009\)](#). An SLA is often considered to be violated if more than a pre-defined percentage of packets breach the agreed metric bound.

2.1.1.3 Quality of Experience

It is apparent that Quality of Service is quantified by measurements and as such is an objective method of characterising network performance. However, another important concept in relation to IPTV is the experience that is perceived by the user so subjective metrics also exist. The primary subjective metric is Quality of Experience (QoE) [Kishigami \(2007\)](#).

As a subjective measurement, it can be reported in many varying manners so work has been undertaken within the ITU to standardise QoE assessment of IPTV, [Takahashi *et al.* \(2008\)](#) and it can be used in place of QoS when evaluating research contributions (e.g. [Balasubramaniam *et al.* \(2011\)](#)).

A model for correlation between QoS and QoE has also been published [Kim & Choi \(2010\)](#) which normalises the values recorded for the QoS metrics into a single value and maps this value to an equivalent QoE value. More recently, a case study was published by [Orosz *et al.* \(2014\)](#) investigating the correlation between QoS and QoE with respect to high definition video streaming.

2.1.2 Traffic Measurement

Traffic measurement is concerned with the collection of the metrics defined previously in Section 2.1.1. In this section, approaches to traffic measurement within telecommunications networks are presented.

2.1.2.1 Simple Network Management Protocol

The Simple Network Management Protocol (SNMP) was first published in RFC 1067 [Case et al. \(1988\)](#) and later updated by what has become the de facto standard in RFC 1901 [Case et al. \(1996\)](#). It is a protocol designed for managing devices within a network. The components that cooperate to perform the functions of SNMP are as follows.

- **Managed Device** A managed device is any device within the network that is operating the SNMP protocol.
- **Software Agent** The software agent is the service that is installed upon the managed device that set and retrieves values and communicates with the SNMP Manager.
- **SNMP Manager** The SNMP Manager is a device within the network that requests and collects information from managed devices within the network and based on its configuration returns values to the software agent to configure the managed device.

The information that is collected from and set on a managed device is stored in a Management Information Base (MIB) [McCloghrie & Rose \(1991\)](#). This is a standardised hierarchical database of information. MIBs are designed to be extensible and can contain very specific or very generic information depending on their configuration.

2.1.2.2 Remote Network Monitoring

Remote Network Monitoring (RMON) is a monitoring specification [Waldbusser \(2006\)](#) that defines objects for managing monitoring devices within a network. The monitoring devices are configured as servers and probes within the network and RMON performs the management and processing of information from these monitoring devices. It is closely related to SNMP as the monitoring devices themselves use SNMP to query the managed devices within the networks.

2.1.3 Traditional Traffic Management Architectures

In a cooperating network environment networks can be configured to treat traffic in a particular manner such that certain criteria are prioritised. For example, traffic sensitive to delay (such as video streaming traffic) can be given priority when traversing network queues. The traditional approaches that have been put forward by the IETF to achieving this are discussed in turn in the following subsections.

2.1.3.1 Integrated Services

Integrated Services (IntServ) is a standard by the Internet Engineering Task Force (IETF) which provides Quality of Service (QoS) guarantees on a per flow basis [Braden *et al.* \(1994\)](#). IntServ operates by getting each node along a path to reserve the bandwidth required by the application. Only if this reservation can take place at each node along the link will the flow be admitted to the network and the QoS guaranteed. This approach is largely considered to not be scalable as core routers on large networks could be required to carry information regarding thousands of flows.

2.1.3.2 Differentiated Services

Differentiated Services (DiffServ) is also an IETF standard [Blake *et al.* \(1998\)](#) which works on similar concepts to IntServ but has advantages in the area of scalability as it is not necessary to store information about each flow at each router. Rather information is stored on each node about how to treat each class of flow. This information is known as the nodes Per Hop Behaviour (PHB). Once this initial setup is done, nodes do not have to keep track of individual flows with the result that DiffServ can scale in a much better fashion than IntServ. Packets in a DiffServ domain are placed into traffic classes by setting the DiffServ Code Point (DSCP) portion of the Differentiated Services field in an Internet Protocol (IP) header.

2.1.3.3 Resource Reservation Protocol

Resource Reservation Protocol (RSVP) is a protocol that operates at the transport layer, and is capable of reserving and allocating bandwidth to single direction flows in the network [Braden *et al.* \(1997\)](#); [Wroclawski \(1997\)](#). The fact that it operates on simplex flows means it differentiates between sending and receiving entities. The successful

operation of RSVP requires the use of two control processes at each intermediate node along the way. One control process ensures that there is enough bandwidth available on the link to meet the requirements of the requested flow. The second control process is responsible for ensuring that the required permissions are in place before the link is reserved. An obvious disadvantage of this per device management is its overhead and associated scalability, similar to that mentioned in relation in IntServ.

2.1.4 Internet Protocol TeleVision (IPTV)

As alluded to in Chapter 1, IPTV is a term that encompasses a vast range of services and technologies. The contributions of this thesis are intended for use in an IPTV environment but are purposely focused on contributions that can be made at an application / service level. A review of the relevant literature in this application level is presented throughout Section 2.2.

However, there are other areas of IPTV architecture that are of relevance but are not directly related to the research work in this thesis. These areas are now presented in the following subsections.

2.1.4.1 IPTV Standard Codecs

As time and technology has progressed the codecs used to transport video data across a network have also progressed. Two main standards bodies (working in conjunction to produce a consistent standard) are responsible for most of the codec progress. These two bodies are the International Organization for Standardization (ISO) in conjunction with the International Electrotechnical Commission (IEC) **ISO/IEC Moving Picture Experts Group (MPEG) (2013)** and the International Telecommunication Union - Telecommunication Standardization Sector (ITU-T) **International Telecommunication Union - Telecommunications Standardisation Sector (ITU-T) (2013)** A range of standards and extensions now cover this area. Those in common use are listed below with their common abbreviations, in order of their publication.

- H.262/MPEG-2 Video (*abbr: MPEG-2*)
- H.264/MPEG-4 Advanced Video Coding **Wiegand *et al.* (2003)** (*abbr: H.264/AVC*)

- H.264/MPEG-4 Advanced Video Coding with Scalable Video Coding Extension [Schwarz *et al.* \(2007\)](#) (*abbr: H.264/SVC*)
- H.265/MPEG-H Part 2 [Sullivan *et al.* \(2012\)](#) (*abbr: H.265/HEVC*)

It has been shown that as these standards progress, the average bit rate they require has reduced but crucially the variability has significantly increased as a result [Gupta *et al.* \(2012a\)](#); [Van der Auwera *et al.* \(2008\)](#). It is these average bit rates and their fluctuations that are of most relevance to this research programme.

2.1.4.2 IPTV Standard Architecture

The standard high level architecture of an IPTV system, shown in Figure 2.1 [Cotton & Kleinmann \(2006\)](#) is designed to show the distribution from the core of the IPTV system through the lesser servers containing a subset of content and on to the clients. It can be considered to be a layered system of caching so that a minimal number of requests must traverse multiple transit networks. To compare this standard architecture to the concepts defined in the research hypothesis (Section 1.1) and more precisely in Figure 1.1, it is equivalent to the intra service provider level of operation. The standard architecture depicts the following logical entities:

- **Super Head End (SHE)** Content with very widespread popularity (e.g. an internationally acclaimed film) is encoded and aggregated here and made available to any VHO that requests it.
- **Video Hub Office (VHO)** Content with more regional popularity scope (e.g. a nationally released film) is encoded at the VHO level and made available to lower levels in the IPTV architecture.
- **Video Sorting Office (VSO)** The VSO aggregates content that has a local appeal (e.g. a citywide information bulletin) and serves all requests to its clients, either via its own content, or its locally propagated instance of content from higher up the logical chain.

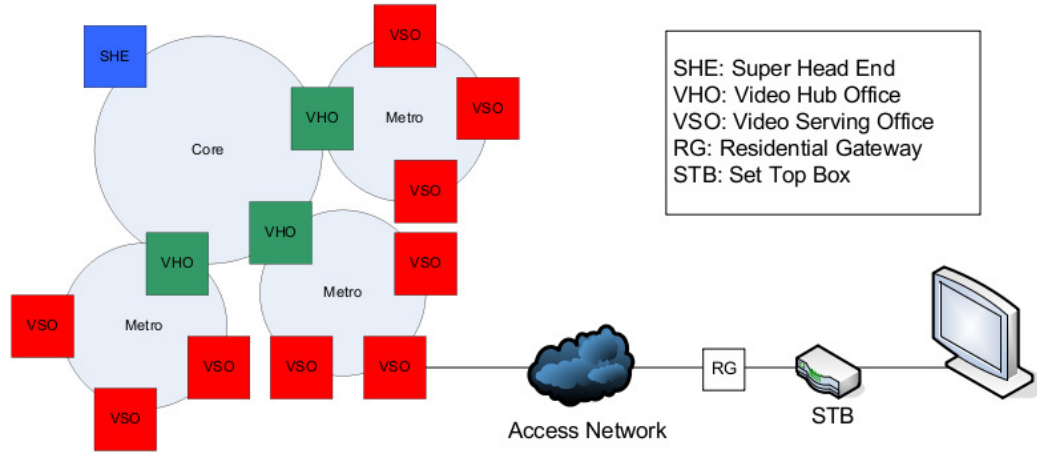

Figure 2.1: IPTV Reference Architecture.

2.2 Literature Review

In the previous section, the background information of related areas was presented. This section undertakes a review of the literature that exists in the areas that are of direct relevance to the research presented within this thesis. The structure of this section is as follows. Section 2.2.1 presents a review of the area of end-to-end available bandwidth estimation. Section 2.2.2 discusses literature relating to content distribution while Section 2.2.3 reviews the area of Admission Control and Server Selection. Section 2.2.4 presents an overview of research that relates to Green Energy within ICT.

2.2.1 Available Bandwidth Estimation

Available Bandwidth is a term that refers to the residual capacity of an end-to-end path when that path is being utilised. A helpful definition of end-to-end Available Bandwidth is given by Cabellos-Aparicio (Cabellos-Aparicio *et al.*, 2008, p.1) and is as follows

The Available Bandwidth of an end-to-end path is its remaining capacity, that is, the amount of traffic that can be sent along the path without congesting it

There are many Available Bandwidth measurement tools present in the research domain, all of which have varying degrees of accuracy. These tools however can be

broadly categorised into two groups, those that are based on the Probe Gap Model (PGM) approach and those that are based on the Probe Rate Model (PRM) approach.

The Probe Gap Model approach uses probe packet pairs or packet trains to determine the Available Bandwidth. It uses these pairs by noting the difference between their network entry time gap, and their network exit time gap. The difference in this time gap is the time the bottleneck link required to service any non probing traffic on the bottleneck hop and this time can be used, along with the link capacity to calculate the Available Bandwidth of the bottleneck link [Strauss *et al.* \(2003\)](#).

The Probe Rate Model approach sends a train of packets and utilises the concept of *self-induced congestion* [Xu & Qian \(2008\)](#). In essence, if the packet train is sent at a rate less than the available bandwidth on the bottleneck link, then the receiving end will receive the packets at the same rate as which they were sent. This is not true of packet trains that are sent at the same rate, or at a rate greater than the Available Bandwidth on the link. These packet trains will be received at a slower rate than that at which they were sent. Finding the highest rate that the packet train is able to transmit packets without added delay allows the Available Bandwidth tool to infer how much bandwidth is available on the link. Examples of each of these approaches are presented in the following subsections.

2.2.1.1 PathChirp

PathChirp [Ribeiro *et al.* \(2003\)](#) is an example of a Probe Rate Model approach. Fundamentally, PathChirp operates by transmitting a set of packet trains called chirps. Each chirp is itself a set of packets of uniform size P which are transmitted at an exponentially decreasing time rate. For each packet k that is a part of packet chirp m , a transmission rate for that instant in time can be calculated as the packet size divided by the time between packets k and $k + 1$. This transmission rate is called the instantaneous chirp rate and is shown mathematically as

$$R_k^m = P / (t_{k+1} - t_k)$$

where t_k represents the time at which packet k was transmitted. It is evident that packet k in the chirp of packets will experience no delay when the available bandwidth is greater than the instantaneous chirp rate R_k . By implication, as the inter packet

spacing decreases the instantaneous chirp rate increases and when this instantaneous chirp rate reaches the rate of the available bandwidth, each successive packet will experience an increasing transmission delay as the path becomes congested. PathChirp operates on the basis that the instantaneous chirp rate of the first packet to experience increasing delay is equal to the available bandwidth. It improves this estimation by taking the average of multiple chirps to represent the available bandwidth.

2.2.1.2 Assolo

Assolo [Goldoni *et al.* \(2009\)](#) also uses a packet train of which contains multiple transmission rates. However, the structure of the train is notably different in Assolo. The probes are more dense around the center of the range of rates as the authors of Assolo maintain this is where the available bandwidth value is most likely to be. The implementation of Assolo provides two filtering mechanisms for dealing with noisy measurements. The first is the standard moving average that is also used by pathChirp and eChirp. The second is the “vertical horizontal filter” [Goldoni & Rossi \(2008\)](#).

2.2.1.3 eChirp

eChirp [Suthaharan & Kumar \(2008\)](#) uses the same underlying principles as pathChirp but estimates are obtained by making slight changes to how probe packets are transmitted, and also by making some changes to how probe packets are analysed. Instead of changing the probing rate for every consecutive probe packet, eChirp sends two packets at the same rate, and then increases the probing rate. This provides eChirp with three sub-trains which it can use to gather information about congestion on the path. The available bandwidth estimates provided by each of these subtrains is combined in a weighted average to create the current available bandwidth estimate.

2.2.1.4 Pathload

Pathload [Jain & Dovrolis \(2002\)](#) also sends trains of probe packets when it is estimating the available bandwidth along a network path. It timestamps these packets with a departure time, and uses comparison between the time differences in arrival and departure times of each pair of packets in the stream. When the delay between the packet pairs starts to consistently increase over the duration of the packet stream,

then the stream is being sent at a rate that is higher than the available bandwidth of the path that it is probing. This fact, combined with the fact that pathload operates iteratively is the basis of the algorithm. The rate of each probing stream is increased if the previous stream failed to cause any sustained increase in the inter packet delays of its transmission. As soon as the first train is sent at a rate that causes an increase in inter packet delay, then pathload uses successive approximation over its remaining iterations to converge on an estimate. One disadvantage of this method is that repeated interaction is required between the sender and receiver to transmit control information such as to increase or decrease the rate of the next packet stream.

2.2.1.5 Spruce

Spruce [Strauss et al. \(2003\)](#) is an example of the Probe Gap Model of available bandwidth estimation. It operates using packet pairs which it injects into the network. The second packet in the pair must arrive in the queue at the bottleneck link before the first departs the queue. Spruce sets the intra-gap time to the transmission time (on the bottleneck link) of a 1500B packet. The amount of traffic on the link can be determined by noting the intra-gap time at the receiver side and using the known transmission rate of the bottleneck link, calculate the volume of traffic on the link. A significant disadvantage of the Spruce algorithm is that it requires pre existing knowledge of the capacity of the bottleneck link, something that is quite often unavailable in end to end available bandwidth estimation. In cases where this is available however, then Spruce has an advantage over the other tools of being very unobtrusive, due to its large and varying inter-gap time.

2.2.1.6 IGI/PTR

The IGI/PTR algorithm [Hu & Steenkiste \(2003\)](#) is another algorithm that uses a train of packets when estimating the available bandwidth. In essence, it sends the packet train out at a high transmission rate, so that the inter packet times are higher at exit than they were at entry to the network. This is due to the bottleneck link causing queues and servicing other traffic in the midst of the packet train. This transmission rate is then reduced until the inter packet entry time is equivalent to the inter packet exit time, referred to as the *turning point* by Hu and Steenkiste.

2.2.1.7 BART and MR-BART

BART [Ekelin *et al.* \(2006\)](#) is a bandwidth estimation tool that sends sequences of probe packet pairs to force the occurrence of self-induced congestion. It uses each new estimate to improve the overall available bandwidth estimate. This is done by employing the statistical process of Kalman filtering [Bishop & Welch \(2001\)](#) to enable near real time estimation. The literature shows BART to be a well performing ABET but its implementation has not been publicly disseminated. MR-BART [Sedighzad *et al.* \(2012\)](#) is a published extension to the approach used by BART. The authors extend BART by applying multi rate probes to the packet pair sequences. This rate variation occurs not just from one probe sequence to another, but also within individual probe sequences.

2.2.1.8 GNAPP

GNAPP [Li *et al.* \(2013\)](#) is a recently published algorithm that utilises the gaps of nonadjacent probing packets for available bandwidth estimation as well as any two consecutive probing packets in the packet train. The assertion is made that GNAPP can estimate the available bandwidth of multiple tight links in a network path individually. By doing this in conjunction with two stage filtering and moving averages, estimation errors are reduced. GNAPP differs from the previously mentioned tools by being a probing method that is applicable to two way available bandwidth estimation.

2.2.1.9 Comparisons and Analyses of ABETs

The above mentioned tools are just a subset of the more popular and well known estimation tools that exist. As the amount of tools available in the literature is significantly large, over the last number of years there has been a growing amount of research being conducted into comparisons and analyses of available bandwidth estimation tools.

[Guerrero & Labrador \(2010\)](#) evaluated the performance of some ABETs in varying scenarios and conditions that had not been the focus of previous analysis. This evaluation included varying the packet loss rate and the propagation delays of the links, varying the amount of cross-traffic and the capacity of the links and also included varying the cross-traffic packet size. From this, they suggested that some ABETs are better candidates than others for particular conditions.

The comparative study of Goldoni & Schivi (2010) focused on the characteristics of the ABETs, namely their accuracy, the time they required to attain an estimate and the amount of traffic they injected into the network path of interest. This intrusiveness on the network was also one of the examined factors in the work by Croce *et al.* (2011). In that comparison, factors such as mutual interference and the total overhead of the available bandwidth estimation tools were also evaluated.

Another significant work is that of Shriram & Kaur (2007) where a comparison of some popular ABETs was undertaken under the following differing conditions: i) traffic load, ii) sampling intensities, iii) measurement timescales, iv) number of bottleneck links and v) location of the bottleneck link.

Recent work has been undertaken by Nguyen *et al.* (2014) to investigate the methods that are present in the literature of filtering the noise from available bandwidth estimates. This work proposes guidelines for correctly selecting the appropriate filter for the experienced network scenarios.

2.2.2 Content Distribution Mechanisms

Content distribution is a vitally important task for an IPTV service provider. However, it is far from a trivial undertaking to perform this distribution as there are many competing demands that must all be catered for. Such demands include the necessity to efficiently manage resources to ensure finances are not spent unnecessarily. This necessity must be accommodated while at the same time ensuring that the content required is easily and quickly delivered in a manner that satisfies the necessary Quality of Service. This required content can be further complicated due to dynamic user behaviour profiles.

In this section, popular methods of content distribution are discussed. Depending on the scale of operation of the IPTV service provider, this content distribution might be performed internally, delegated to an external company or achieved via a combination of both.

2.2.2.1 Content Delivery Networks

The purpose of a Content Delivery Network (CDN) is to distribute content, often via content replication algorithms Chen *et al.* (2003) and cache-validity algorithms Liu *et al.*

(2010) to ensure quick access to requested content. Content is located and delivered using means such as URL and DNS redirection [Vakali & Pallis \(2003\)](#).

The power of a CDN comes from its scale of operation. This can be seen at its most prolific when discussing the most widespread and comprehensive Content Delivery Network, [Akamai \(2013\)](#). Akamai has over 61000 servers distributed around the world [Nygren *et al.* \(2010\)](#). Other CDNs of varying sizes are also in operation (e.g. the Amazon service, Cloudfront [Cloudfront \(2013\)](#)). An overview of the many processes that operate in a CDN environment can be found in [Nygren *et al.* \(2010\)](#).

2.2.2.2 Peer to Peer Delivery

Peer to Peer (P2P) Delivery of IPTV content works without any centralized infrastructure to distribute content. In theory each node operates as both a receiver and sender of IPTV content, although it is regularly the case that a subset of more powerful nodes end up operating as video proxies and contributing significantly to the upload and sharing of the content [Hei *et al.* \(2007\)](#).

Peer to Peer delivery can be divided into a tree-based approach and a mesh-based approach. The tree based approach (such as [Kostić *et al.* \(2003\)](#)) involves nodes setting up in a heirarchical structure whereas the mesh based approach (e.g. [Magharei & Rejaie \(2009\)](#)) is a more orthodox peer to peer architecture that is not hierarchical. CoolStreaming [Zhang *et al.* \(2005\)](#) and SopCast [Sopcast \(2013\)](#) are just some examples of peer to peer systems that are in popular existence.

Some significant issues [Liu *et al.* \(2008\)](#) still exist within the peer to peer approach to IPTV delivery. Due to the startup delay involved in connecting to peers, many end users experience a playback lag in the order of tens of seconds. Another issue is the fact that peer to peer traffic is considered to be ISP unfriendly as it is high cost and volume but very limited financial benefit. This is due to the fact that Peer to Peer traffic is agnostic of the underlying ISP architecture and willingly routes traffic out of an ISPs network, increasing their costs [Aggarwal *et al.* \(2007\)](#).

2.2.3 Admission Control

The objective of Admission Control is to control access to a particular resource within the network e.g. access content from a server or request bandwidth on a high speed network path. Admission Control is usually performed at the network ingress point,

when a request is received for access to a resource. The most obvious form of admission control works simply on the principle that the flow will be admitted if there is sufficient spare bandwidth to accommodate the expected maximum requirements of the new flow [Nam *et al.* \(2008\)](#). More complex admission control algorithms also exist, for example, admission control for the purpose of admitting flows that can generate significant amounts of revenue [Davy *et al.* \(2008\)](#), or any other metric the network operator might consider to be of importance. Admission control algorithms can traditionally be categorised into the following headings:

2.2.3.1 Parameter Based Admission Control

Parameter Based Admission Control (PBAC) [Fidler & Sander \(2004\)](#) refers to admission control based on some defining value (parameter) that is present *a priori* about the traffic flow requesting admission. The total of the peak rates of all such flows is compared to the capacity of the link. This approach to admission control is known to be inefficient as it under utilises the resources available due to its use of the peak rates of all the flows admitted. RSVP can be considered to be part of this type of admission control as capacity is reserved along the path based on a particular parameter present in the TSpec attribute of the RSVP request.

2.2.3.2 Measurement Based Admission Control

Measurement Based Admission Control (MBAC) uses measurements obtained about the existing traffic to learn the characteristics of future flows. These characteristics are then used to determine whether or not a newly arriving flow can be incorporated successfully. Purely measurement based admission control algorithms exist ([Jamin *et al.* \(1997\)](#) provides a comparison of these, as do others), but more recently the MBAC approach has been adapted to include *a priori* knowledge of the incoming traffic flows [Georgoulas *et al.* \(2005\)](#).

2.2.3.3 Experience Based Admission Control

Experience Based Admission Control (EBAC) [Menth *et al.* \(2004\)](#) uses the peak rate reported by a new flow and its experience about the actual bandwidth subsequently used to calculate an *overbooking factor*. This overbooking factor determines how much

over the actual capacity of the link can be reserved by new flows, while maintaining the desired levels of QoS. The concept here is that the flows will not all require the amount of bandwidth stated in their peak rate, and thus better utilisation can be achieved without violating QoS by incorporating this overbooking factor.

2.2.3.4 Admission Control for IPTV

As well as the literature reviewed above discussing the traditional approaches to admission control, there has been research published that is of specific relevance to an IPTV service provider from a Quality of Service perspective. In [Latré & De Turck \(2013\)](#), an approach to measurement based Admission Control is presented that utilizes Pre Congestion Notification (PCN) [Eardley \(2009\)](#) to gather measurements and dynamically control Quality of Experience levels.

Elsewhere, [Asghar *et al.* \(2009\)](#) use RSVP [Braden *et al.* \(1997\)](#) as part of an architecture for Admission Control in a CDN network. A drawback of this approach is that it requires the cooperation of every node along the network path to operate successfully.

In [Chandra & Sahoo \(2009\)](#), the authors propose an algorithm for selecting the server that would minimize response and completion times based on the current capabilities of the servers. This approach was therefore focused on server performance as opposed to network traffic performance. More recently, [Tran *et al.* \(2014\)](#) propose a QoE-based server selection algorithm that is designed for use in a CDN environment

[Carlsson & Eager \(2010\)](#) proposed an approach that examined client start up delay and the total delivery cost. However, their priority was the cost incurred and not the Quality of Service of the content.

2.2.4 Green Energy in ICT

In Chapter 5 of this thesis, research relating to Green Energy optimisation is presented. Part of this research work is conducted using an evolutionary approach to optimisation of data centre workloads. To support this, this section reviews relevant literature in the area of optimisation and Green Energy management within ICT.

Multi-objective optimisation is concerned with the design and implementation of algorithms that have multiple potentially conflicting goals. Many non-evolutionary approaches to optimisation in data centres also exist within the published literature. In [Feng *et al.* \(2012\)](#), an algorithm based upon Nash bargaining was presented with

the goal of maximising resource utilization such as CPU cycles and storage but the effect on Green Energy usage was not considered. [Wu *et al.* \(2012\)](#) performs request distribution by characterising the social influences of users coupled with “one shot” content migration based upon efficient optimisation. [Bagci \(2014\)](#) assigns resources based upon queueing models that take into consideration how adding resources will impact the green energy usage.

Much of this workload optimisation research has incorporated Green Energy awareness. For example, [Liu *et al.* \(2011\)](#) presents distributed algorithms for optimally load balancing amongst geographically distributed locations to improve green energy utilisation. In [Ilyas *et al.* \(2012\)](#), the authors discuss a framework for optimal workload distribution (with respect to electricity costs) amongst a set of data centres while the work of [Gmach *et al.* \(2010\)](#) presents an approach to energy capacity planning that matches time-varying energy supply to separately time varying energy demand. In [Peoples *et al.* \(2013\)](#), Peoples et al present an approach to consolidate workload into servers (dependant on their cost to operate) in a manner that is cost-efficient.

In [Zhang *et al.* \(2011\)](#), Zhang et al base server selection amongst geographically distributed data centres with various amounts of green energy to minimise the operations cost but do not give consideration to the Quality of Service that is resultant in the network. The research of [Adnan *et al.* \(2012\)](#) presents a load balancing approach that dynamically defers and migrates workload in order to adapt with changing energy costs.

Multi-objective optimisation is an area of research that has long been suited to the use of evolutionary-based methods [Zitzler & Thiele \(1998\)](#) and the increased viability of utilising optimisation methods has made it an appealing method for Green Energy management. For example, in [Barbagallo *et al.* \(2010\)](#) an algorithm is presented that redistributes the load, to enable a better energy management by turning off servers that are not needed. Other evolutionary based approaches include the work of Garg et al whose approach addresses this problem from the perspective of the overall usage of Cloud Computing resources [Garg *et al.* \(2011\)](#), and [Yusoh & Tang \(2010\)](#) who suggest a penalty-based genetic algorithm (GA) for distributing services within the cloud.

2.3 Summary

This chapter presented a review of published literature that is of relevance to the research questions identified in Chapter 1. The chapter commenced with a discussion of the historical information and concepts in the general area of network management. Information relating to standards within IPTV (such as popular CODECs and a standardised architecture) were also discussed.

Following this, literature in the area of available bandwidth estimation was reviewed. It is apparent from this review that end to end available bandwidth estimation is a mature area of research and comparisons into the performance of existing ABETs exist and can be used when considering the suitability of using an ABET in an application scenario. These comparisons informed the research conducted within Chapter 3 and ensured any framework that utilised an ABET was designed in a modular fashion to enable swapping the ABET used if required.

Admission Control was also reviewed, both with respect to the traditional approaches and specifically in relation to IPTV. It was found that most of the research conducted within this area requires some form of cooperation from intermediate nodes and as such is of limited use to over the top IPTV service delivery.

Content Distribution mechanisms were also discussed due to their relevance to research that is concerned with the management of IPTV performance and resources. The growing importance of Green Energy awareness in ICT was also highlighted, with a focus on literature concerning workload optimisation by service providers.

From the literature presented in these reviews, it is apparent that previously existing research has not thus far addressed the research questions identified in the first chapter. As a result of this, the research presented in subsequent chapters can be seen to be both novel and needed contributions.

Chapter 3

Feasibility of Using ABETs for IPTV Admission Control

In this chapter, the focus is on addressing the first research question (Section 1.1.1). The work presented here can be found in three publications, namely Meskill *et al.* (2010, 2011) and the collaborative work undertaken in Botta *et al.* (2013).

Addressing this first research question is achieved by firstly performing a comparison of some Available Bandwidth Estimation Tools. A vital factor in this comparison is the relative performance of the tested ABETs in topologies of various complexity. This is of importance as this research is focused on providing benefits to an IPTV service provider who is delivering content in an Over-The-Top (OTT) manner, i.e. across an uncontrolled intermediate topology.

Having completed this comparison of the ABETs, this chapter progresses by using the results of this comparison to inform a discussion about which ABETs are suitable for use in an IPTV environment and what parameterization is required. An algorithm to govern Server Selection and Admission Control that utilises Available Bandwidth estimation is introduced and its performance relative to other Admission Control strategies is determined. Some observations on the incorporation of Available Bandwidth Estimation into IPTV Admission Control are also presented.

This chapter concludes with an overview of the work undertaken to address the first research question and the summarised core contributions are highlighted and presented.

3.1 Comparison of Available Bandwidth Estimation Tools

Much of the literature relating to end-to-end Available Bandwidth Estimation has focused on the development of readily implemented estimation algorithms, which are often evaluated with either simulation studies using single network topologies which are not reflective of actual network paths, or tested empirically across the Internet, with its realistically complex topology and varying background traffic conditions but no control or guarantee over the actual capacity levels present along the path.

In the comparison undertaken here, accuracy is the primary criteria that is focused upon as this is the core objective of any ABET tool. Also, an ABETs accuracy will be of direct relevance to any QoS inferences that can be made for an IPTV scenario. Nevertheless, the ability to control and vary the overhead and robustness of the examined ABETs is also of importance and is discussed in Section 3.2 from an IPTV usage viewpoint.

The OPNETTM Modeler [OPNET Modeler \(2013\)](#) simulation environment is used to examine the effect topology complexity has on the accuracy of congestion based Available Bandwidth Estimation Tools. Topologies are simulated in which one, two or three links on the network path (for which available bandwidth is being estimated) carry significant amounts of cross traffic. Throughout this section, the influence of this cross traffic on the ABETs under evaluation is examined. These ABETs are pathChirp [Ribeiro *et al.* \(2003\)](#), Assolo [Goldoni *et al.* \(2009\)](#) and eChirp [Suthaharan & Kumar \(2008\)](#). Assolo is examined using both forms of filtering available in its implementation (as mentioned in Section 2.2.1.2) and these are referred to as Assolo_MA and Assolo_VHF respectively.

The justification for choosing the ABETs mentioned from the plethora of tools in existence is as follows: pathChirp was chosen as it is regarded as one of the better tools available [Shriram & Kaur \(2007\)](#) and is often the baseline when judging new tools e.g. [Cabellos-Aparicio *et al.* \(2008\)](#). Both Assolo and eChirp are variations on the pathChirp algorithm, and are therefore likely candidates for comparison.

3.1.1 Experimental Setup

Three simulated topologies of increasing complexity were examined. In all these topologies, the network links are standard Fast Ethernet links and have a capacity of 100

3.1 Comparison of Available Bandwidth Estimation Tools

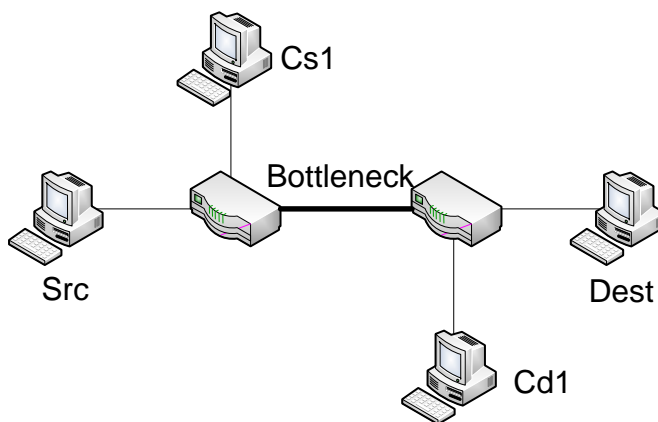

Figure 3.1: Experiment topology with one cross traffic flow.

Megabits per second (Mbps). The routers in these topologies are labelled $R1$, $R2$, etc as they progress from the network path source src to the network path destination $Dest$. For clarity, these router labels are not present in the topology diagrams (Figures 3.1 to 3.3).

The first topology shown in Figure 3.1 consists of a network path containing 3 links, one of which was subjected to cross traffic. Probe packets belonging to the ABETs were sent from Src to $Dest$ and the cross traffic was transmitted from the cross traffic source $Cs1$ to the cross traffic destination $Cd1$ with a resultant bottleneck between $R1$ and $R2$.

For the second topology (Figure 3.2), complexity is added by increasing the number of links on the path as well as the number of links that are subject to cross traffic. In this topology, cross traffic is present upon two of the links on the network path, $Cs1$ to $Cd1$ and $Cs2$ to $Cd2$. with the latter being the significantly identifiable bottleneck. The links subjected to cross traffic are not consecutive. This helps to prevent a scenario where the traffic is skewed by the amalgamation of the cross traffic at any of the intermediate nodes. The bottleneck is located between $R3$ and $R4$ in this topology.

The third topology (Figure 3.3) tested continues the methodical approach. A third cross traffic flow is introduced. The setup of this topology is as follows. Cross traffic flows are created between $Cs1$ and $Cd1$ as well $Cs2$ and $Cd2$. A third cross traffic flow between $Cs3$ and $Cd3$ operates as the bottleneck on the path between $R5$ and $R6$.

The ABETs were tested using both Constant Bit Rate (CBR) and Variable Bit Rate (VBR) cross traffic profiles. The CBR traffic consisted of 1000byte packets, the volume

3.1 Comparison of Available Bandwidth Estimation Tools

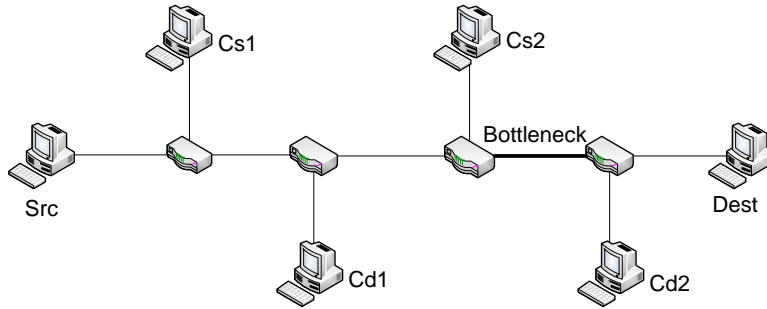

Figure 3.2: Experiment topology with two cross traffic flows.

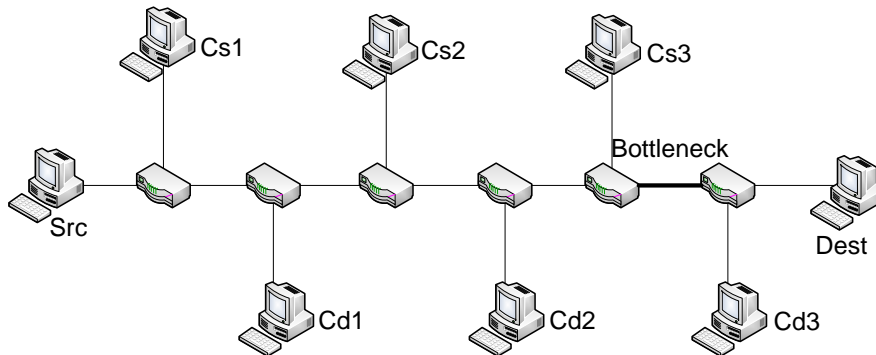

Figure 3.3: Experiment topology with three cross traffic flows.

3.1 Comparison of Available Bandwidth Estimation Tools

Table 3.1: One Hop CBR Error Results.

	MINIMUM	MAXIMUM	AVERAGE
pathChirp	0%	30.19%	8.14%
Assolo_MA	0.03%	23.69%	6.62%
Assolo_VHF	1.95%	62.79%	33.12%
eChirp	8.05%	47.78%	27.68%

and speed of which was varied to create the cross traffic profiles required (presented below). The VBR traffic was composed of video traces [Gupta *et al.* \(2012b\)](#); [Seeling & Reisslein \(2012\)](#) which were used to generate VBR traffic streams from video servers at the position of the cross traffic sources. The video trace used has a mean throughput of 270kbps. To create different volumes of traffic on the different links, the amount of clients receiving video traces from each server was varied. To alleviate the initial high demand video traces exhibit on commencement, the starting time for each stream was selected randomly using a uniform distribution with range (50s, 150s). It was possible to measure the actual available bandwidth on each of the network links using internally collected statistics available within Opnet Modeler.

3.1.2 Constant Bit Rate Results

Results demonstrating the performance of the studied estimation tools are presented for the scenarios where the three topologies described above are subjected to CBR cross traffic.

3.1.2.1 Topology One

In the first scenario, the available bandwidth is the remaining capacity on the link between $R1$ and $R2$. The CBR traffic generator sent traffic at a rate of 40Mbps. This gives an available bandwidth which is reported by OPNET as averaging around 58Mbps. Table 3.1 summarises the accuracy levels for each of the ABETs tested in this scenario.

3.1 Comparison of Available Bandwidth Estimation Tools

Table 3.2: Two Hop CBR Error Results.

	MINIMUM	MAXIMUM	AVERAGE
pathChirp	0.15%	41.83%	22.09%
Assolo_MA	1.46%	40.93%	22.7%
Assolo_VHF	2.22%	62.92%	35.25%
eChirp	24.24%	58.45%	42.48%

Table 3.3: Three Hop CBR Error Results.

	MINIMUM	MAXIMUM	AVERAGE
pathChirp	16.59%	62.88%	43.26%
Assolo_MA	16.18%	44.58%	33.43%
Assolo_VHF	1.5%	61.98%	38.65%
eChirp	41.28%	72.11%	58.35%

3.1.2.2 Topology Two

This scenario examines the effect of having a second cross traffic flow on the measured path. The link between $R3$ and $R4$ is the bottleneck link in this experiment. Using CBR cross traffic, a 20Mbps load was added to the link $R1$ and $R2$ while a 40Mbps load was added to the link between $R3$ and $R4$. This created an available bandwidth of approximately 79Mbps and approximately 58Mbps respectively. The error in accuracy for all the ABETs is presented in Table 3.2.

3.1.2.3 Topology Three

The bottleneck for this topology is the link between $R5$ and $R6$. On the first link experiencing cross traffic the available bandwidth is approximately 79Mbps, while the second has approximately 69Mbps. The bottleneck link has an available bandwidth of approximately 58Mbps and the accuracy of each of the ABETs at estimating this is shown in Table 3.3.

3.1.3 Variable Bit Rate Results

The performance of the ABETs was also analysed using VBR traffic, and inaccuracy levels of the various ABETs for this frequently changing traffic are presented below for

3.1 Comparison of Available Bandwidth Estimation Tools

Table 3.4: One Hop VBR Error Results.

	MINIMUM	MAXIMUM	AVERAGE
pathChirp	0.02%	39.18%	10.13%
Assolo_MA	0%	30.6%	6.96%
Assolo_VHF	0%	75.36%	13.56%
eChirp	0.07%	57.7%	20.84%

Table 3.5: Two Hop VBR Error Results.

	MINIMUM	MAXIMUM	AVERAGE
pathChirp	0.03%	60.1%	16.36%
Assolo_MA	0.11%	58.11%	11.23%
Assolo_VHF	0%	75.64%	17.7%
eChirp	1.61%	66.79%	26.61%

each of the test topologies.

3.1.3.1 Topology One

In the first scenario, the available bandwidth at the bottleneck between $R1$ and $R2$ was created by having 36 clients receive the video trace, as described in the setup discussed in Section 3.1.1. The levels of inaccuracy for each of the tools are summarised in Table 3.4.

3.1.3.2 Topology Two

This scenario introduces a second VBR cross traffic flow on the measured path. The bottleneck for this topology is the link between $R3$ and $R4$ and is created by having twice as many video traces transferring between $R3$ and $R4$ than is transferring between $R1$ and $R2$. This means 18 clients were creating cross traffic on the link between $R1$ and $R2$ while 36 clients were creating cross traffic on the link between $R3$ and $R4$.

3.1.3.3 Topology Three

The final scenario in this section deals with having three cross traffic flows. To create the cross traffic for this experiment, 18 clients congested the link between $R1$ and $R2$, 27 clients congested the link between $R3$ and $R4$ and the bottleneck was congested by

3.1 Comparison of Available Bandwidth Estimation Tools

Table 3.6: Three Hop VBR Error Results.

	MINIMUM	MAXIMUM	AVERAGE
pathChirp	0.24%	69.09%	23.87%
Assolo_MA	0.24%	42.75%	15.68%
Assolo_VHF	0.03%	76.01%	23.46%
eChirp	7.95%	78.59%	33.02%

36 clients. The bottleneck for this topology is the link between $R5$ and $R6$ and two other cross traffic flows are present between the links $R1$ to $R2$ and $R3$ to $R4$. The accuracy of each of the studied ABET tools is presented in Table 3.6.

3.1.4 Influence of Bottleneck Location

When testing the ABETs using multiple topologies, the issue of where to locate the bottleneck was considered. In the results presented so far, the bottleneck was restricted to the last hop that was subject to cross traffic. However, as observed by [Shriram & Kaur \(2007\)](#), this is not always the case, so the difference in accuracy due to the location of the bottleneck was also investigated. In this section, the error in accuracy of pathChirp with relation to the bottleneck location when using CBR traffic. It should be noted that all the tools tested support the trends shown in this section for both CBR and VBR traffic, but only this subset is presented to prevent a repetition of similar graphs and results.

3.1.4.1 Two hops containing cross traffic.

In Section 3.1.2.2, the situation where the bottleneck was the second of the two hops was dealt with. The error in accuracy when the bottleneck comes first in the network path (Table 3.2) was also examined. Table 3.7 compares the error between this scenario and the scenario in Section 3.1.2.2 This table shows there is only a minor difference between the average error in these two cases.

3.1.4.2 Three hops containing cross traffic.

To further validate this trend, a comparison between the bottlenecks potential location in the three hop scenario is presented. Table 3.8 presents all the statistics from the

3.1 Comparison of Available Bandwidth Estimation Tools

Table 3.7: Accuracy in topology with two hops cross traffic.

<i>Bottleneck Location</i>	MINIMUM	MAXIMUM	AVERAGE
First Hop	0.01%	45.05%	23.06%
Second Hop	0.15%	41.83%	22.09%

Table 3.8: All scenario variations for three hops containing cross traffic.

Available Bandwidth			Estimate Error		
<i>Link 1</i>	<i>Link 2</i>	<i>Link 3</i>	<i>Minimum</i>	<i>Maximum</i>	<i>Average</i>
80Mbps	70Mbps	60Mbps	16.59%	62.88%	43.26%
70Mbps	80Mbps	60Mbps	21.77%	60.96%	43.40%
70Mbps	60Mbps	80Mbps	23.44%	61.60%	43.81%
80Mbps	60Mbps	70Mbps	20.76%	60.64%	42.85%
60Mbps	70Mbps	80Mbps	21.57%	58.14%	42.50%
60Mbps	80Mbps	70Mbps	13.43%	60.30%	43.17%

three hop cross traffic scenario, with the location of the bottleneck highlighted in bold font. The minor deviation in average error amongst the various experiments containing both two and three hops cross traffic clearly shows that the location of the bottleneck is not a significant factor in the accuracy of a congestion based ABET.

3.1.5 Discussion of Experimental Results

These results clearly show a trend of significantly increasing inaccuracy as the topology used increases in complexity. This trend is noticeably present for both constant and variable bit rate traffic, and also for all the ABETs that are examined. The cause of this increased inaccuracy can be seen by examining the structure of the ABET packet trains at a particular time for all of the scenarios mentioned. It can be seen that even though all scenarios have the same bottleneck condition, the existence of cross traffic (albeit a smaller amount) on other queues along the path can serve to add extra delay to packets within the train, thus having a significant effect on the signature of the packet train, and reducing the value of available bandwidth as estimated by the ABET.

This effect is illustrated graphically in Figure 3.4, which uses data points collected during the experiments that were undertaken. This illustration clearly shows the extra delay caused by additional cross traffic along the path, showing that the interarrival

3.1 Comparison of Available Bandwidth Estimation Tools

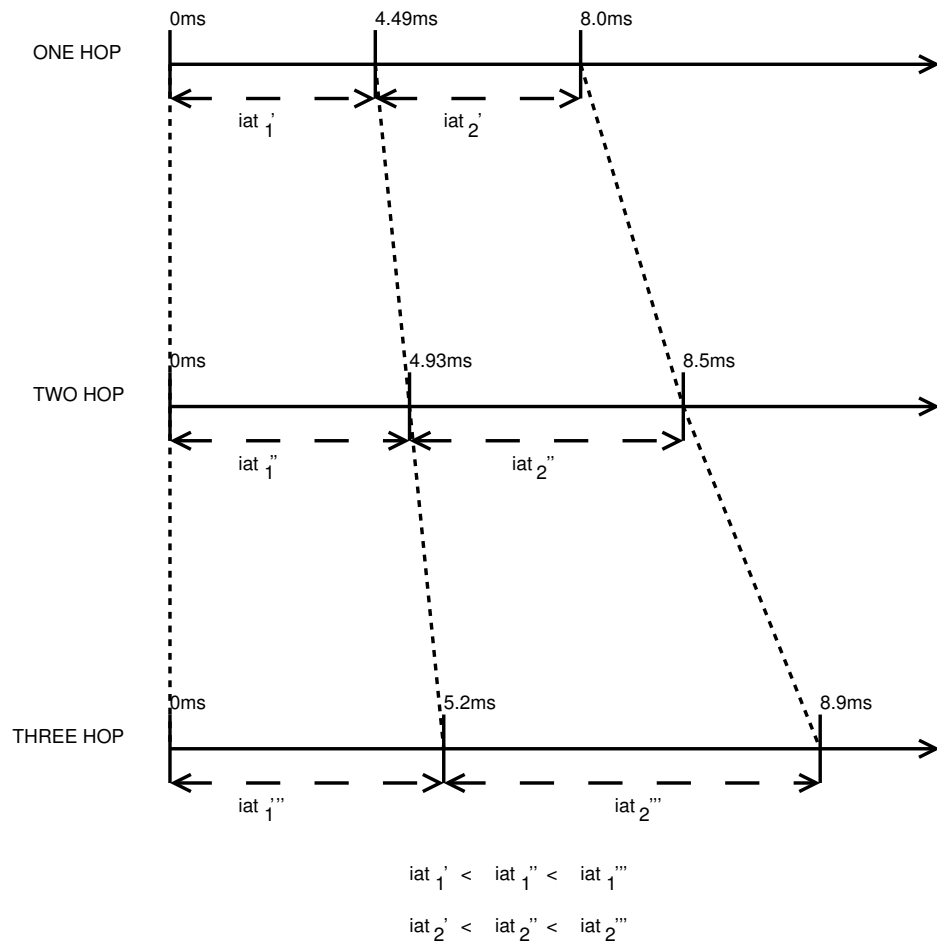

Figure 3.4: pathChirp packet train interarrival times in milliseconds for all scenarios.

3.1 Comparison of Available Bandwidth Estimation Tools

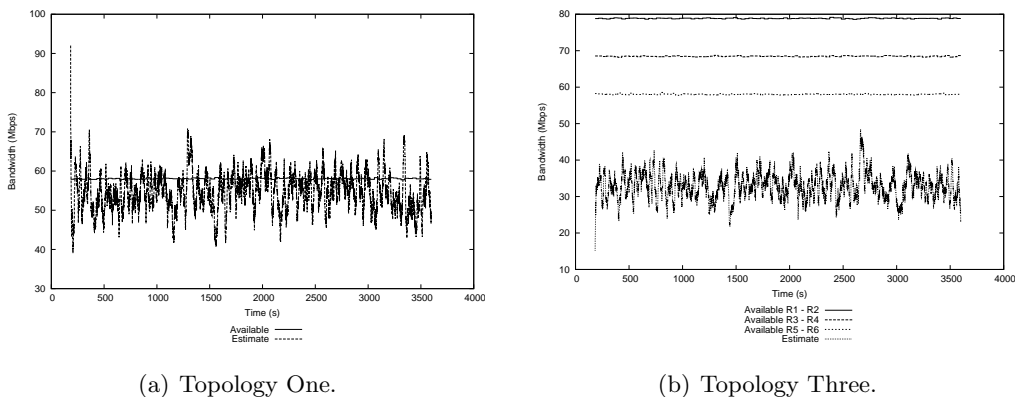

Figure 3.5: Topology comparison for CBR traffic using pathChirp.

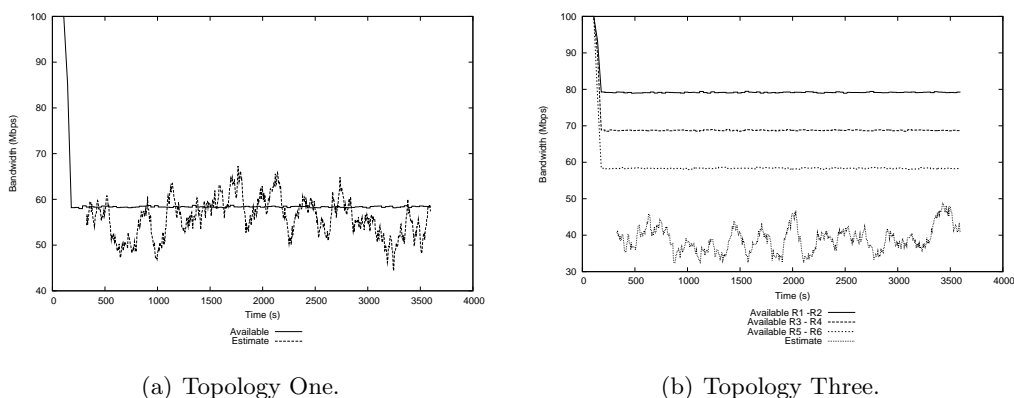

Figure 3.6: Topology comparison for CBR traffic using Assolo_MA.

times of each packet in the train grows as it is required to traverse more hops. This changes the signature of the packet train such that the ABET considers the path to be congested sooner and thus, the ABET reports more conservative estimates. The end effect of this change in the packet train signature is shown for each of the tools under CBR traffic in Figures 3.5 to Figures 3.8.

Comparing the results of like experiments for each of the tools studied serves to highlight the requirement for using appropriate topologies for testing the suitability of congestion based ABETs for a particular application purpose. It can be seen that all the tools examined vary in the degree to which they are affected by increasing numbers of cross traffic flows. In a simple topology, all four tools studied provide estimates that may be within an acceptable range of accuracy for their intended use. However, as

3.1 Comparison of Available Bandwidth Estimation Tools

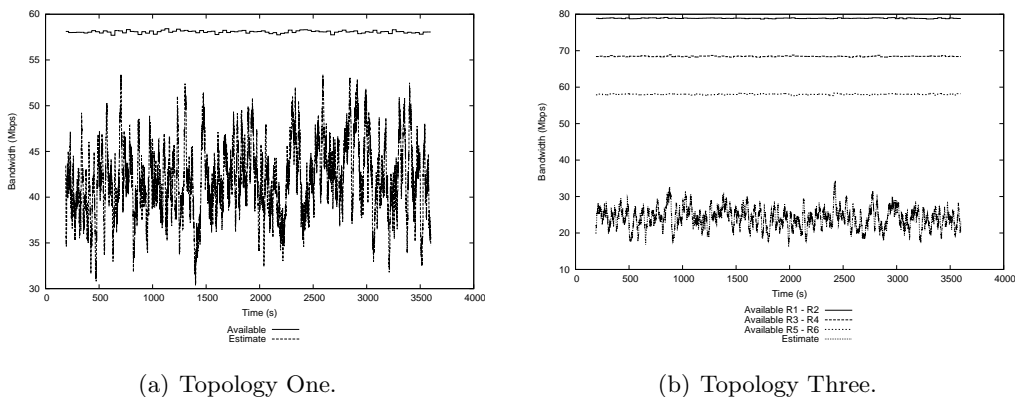

Figure 3.7: Topology comparison for CBR traffic using eChirp.

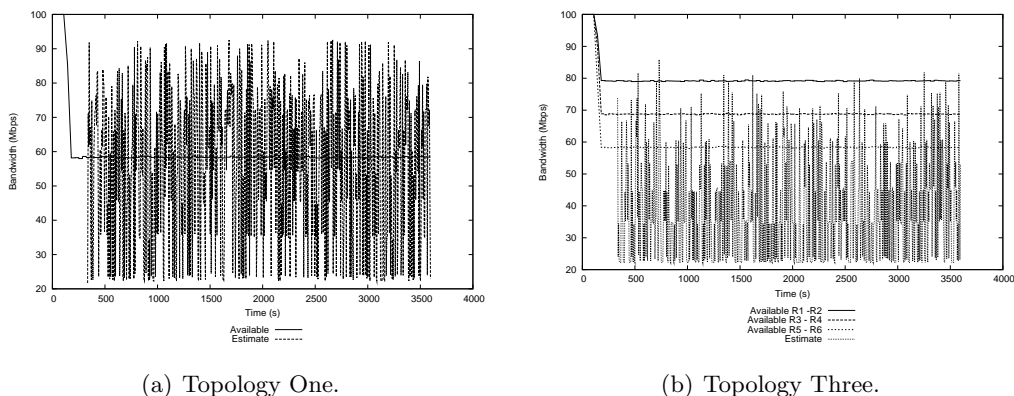

Figure 3.8: Topology comparison for CBR traffic using Assolo_VHF.

the topology complexity increases, eChirp becomes too inaccurate for all but the most lax of accuracy requirements, whereas pathChirp and both versions of Assolo are more broadly applicable. This is despite the obvious fact that the accuracy of these tools also degrades as the topology becomes more complex.

It is worth noting that Assolo_VHF does not show the same level of increase in inaccuracy as the other tools. It does however show more inaccuracy in the simpler of the topologies. It is felt this is due to the operation of the VHF filter which is far more influenced by the most recent estimate than a standard moving average is. Most importantly, it can be seen that the relative performance of the tools varies significantly with the topology complexity. It can therefore be concluded that when undertaking comparative analysis of congestion-based ABETs it is important to compare their per-

formance when operating in a range of topologies and not in a single, simple topology as has been the case in most of the studies to date.

3.2 Using ABETs in IPTV Server Selection / Admission Control

In the previous section, it was shown that eChirp is not suitable for use in an IPTV scenario as it is too inaccurate even in the most simplistic topology. It was also shown that Assolo_VHF, whilst more robust to topology complexity, is too inaccurate for use in the required IPTV scenario. Therefore, the ABETs used to obtain estimates and validate the use of Available Bandwidth Estimation in Admission Control are pathChirp and Assolo_MA, referred to from here simply as Assolo. Both these tools have configurable parameters which can influence their effectiveness in an Admission Control situation. These parameters are presented:

- **Spread Factor** Many congestion based ABETs have this parameter (sometimes named differently). This affects the amount of probing rates used by the available bandwidth estimation tool to generate an estimate. More probing rates leads to a more finely tuned result, but the result takes longer to generate and leave a heavier footprint on the network as the probing train needs to send more data.

To compare the affect of the spread factor on the objective of minimising end to end delay whilst maximising requests accepted, 3 values were chosen for the spread factor that correspond to having a high, medium or low amount of probing rates. These values were 1.2, 1.5 and 1.8 respectively. Figure 3.9 shows the end to end delay experienced by the video transmissions in each of these cases. It can be seen that increasing the spread factor does not affect the QoS linearly. The difference in number of rates between 1.5 and 1.8 is much more significant than between 1.2 and 1.5.

- **Inter Estimate Time** As the available bandwidth estimation process uses a moving average to calculate the current available bandwidth on a path, the inter estimate time can influence how long it takes for the estimate to update after a change in the bandwidth that is available. Obviously the shorter the time between estimates, the faster an ABET can become aware of changes in the

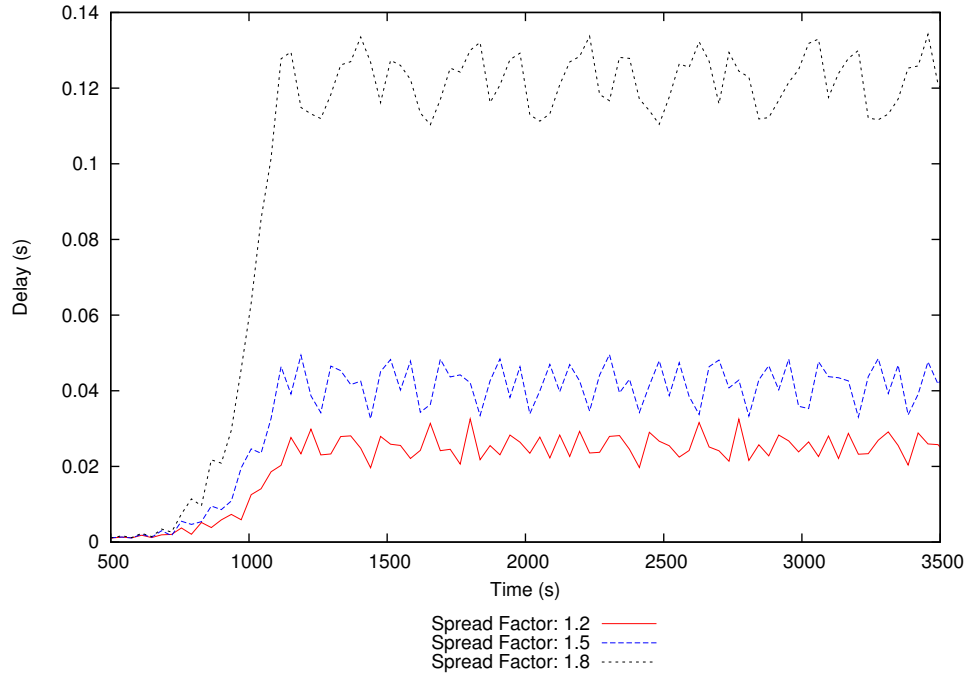

Figure 3.9: End-to-end delay with varying Spread Factor values.

available bandwidth. However, in a system such as Admission Control for a content delivery network, it is necessary to find the balance between receiving available bandwidth estimates quickly and not creating unacceptable congestion to the network by having many probe packets on the network path.

While it can be seen from Figure 3.10 that as the inter estimate time lowers so does the end to end delay, an inter estimate time of one second requires a high overhead of control and probe packets, thus the next best value of **5 seconds** is used in the presented admission control approach.

- Moving Average Size** By increasing the size of the moving average an older and potentially inaccurate value can influence the current estimate for longer. However, a balance must be found as decreasing this value will result in available bandwidth estimates that fluctuate more rapidly due to being more susceptible to short term changes in the bandwidth utilization. The default value of 30 that is used by pathChirp was examined, as were lower and higher values of 20 and 40 respectively.

3.2 Using ABETs in IPTV Server Selection / Admission Control

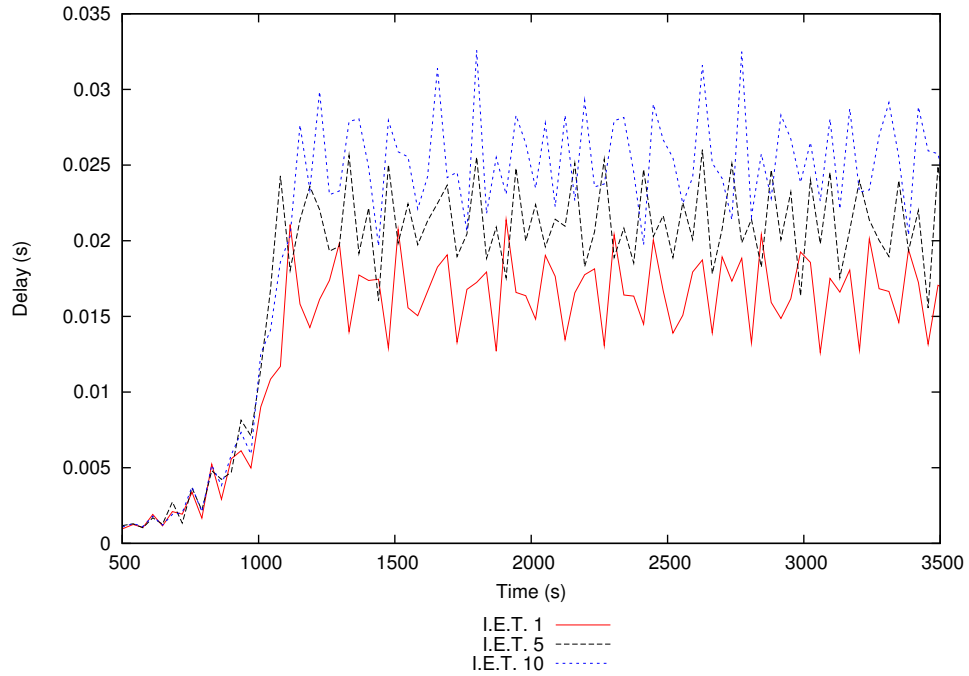

Figure 3.10: End-to-end delay with varying Inter Estimate Times.

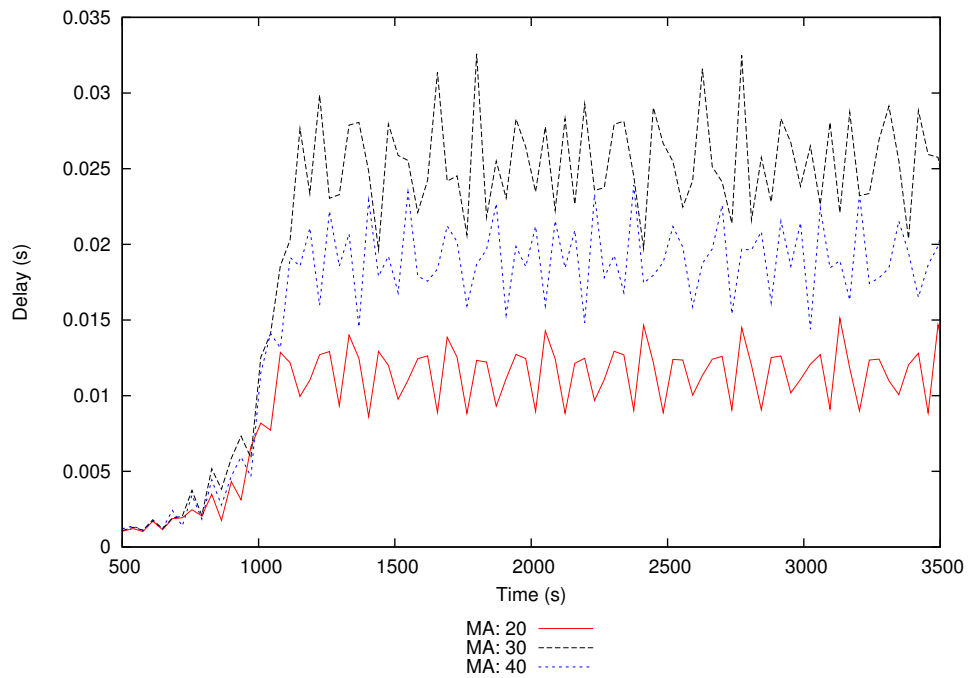

Figure 3.11: End-to-end delay with varying Moving Average values.

Figure 3.11 shows the variation in end to end delay caused by changing this parameter. The improved delay when using a **value of 20** for this parameter is again deemed to be more important than the slight decrease in the number of requests accepted that was seen with lower values.

The combined selection of values for these parameters have an affect on the end to end delay the network will experience as shown. This is due to the fact that these parameters affect how conservative the ABET is in its estimations. The approach taken is to be conservative with these estimates. This results in better end to end delay for fewer accepted requests but it is possible to alter this trade-off using these parameters to allow more requests with higher end to end delay.

With the aforementioned parameters optimized, the suitability of pathChirp and Assolo as Admission Control inputs was examined. Figures 3.12 and 3.13 show the end to end delay experienced by content traffic and the amount of flows admitted. It can clearly be seen that an Admission Control system using pathChirp rejects more requests and exhibits lower delay and better performance. It is felt that pathChirp is a more suitable ABET for this scenario due to the approach it uses to calculate Available Bandwidth measurements. PathChirp sends more packets at low probing rates making it better equipped to deal with small changes when there is low bandwidth available on a path. This is in comparison to Assolo which has most of its probing rates around the middle of its range of rates. Overall, this results in pathChirp being more cognizant of slight reductions in the bandwidth, allowing it to reject requests accordingly and preserving the Quality of Service of admitted flows (Figure 3.12). The sacrifice for this better QoS is to have less flows admitted, as shown in Figure 3.13.

Based on this, this research is continued using pathChirp as the ABET that informs the decisions taken and policies implemented as it is sufficiently accurate for its required purpose. However, the Admission Control framework (described subsequently) is designed to consist of loosely coupled components and as such pathChirp can be replaced with any superior ABET that becomes available. In [Botta *et al.* \(2013\)](#), such an adaptive selection of ABET tools is considered.

3.2 Using ABETs in IPTV Server Selection / Admission Control

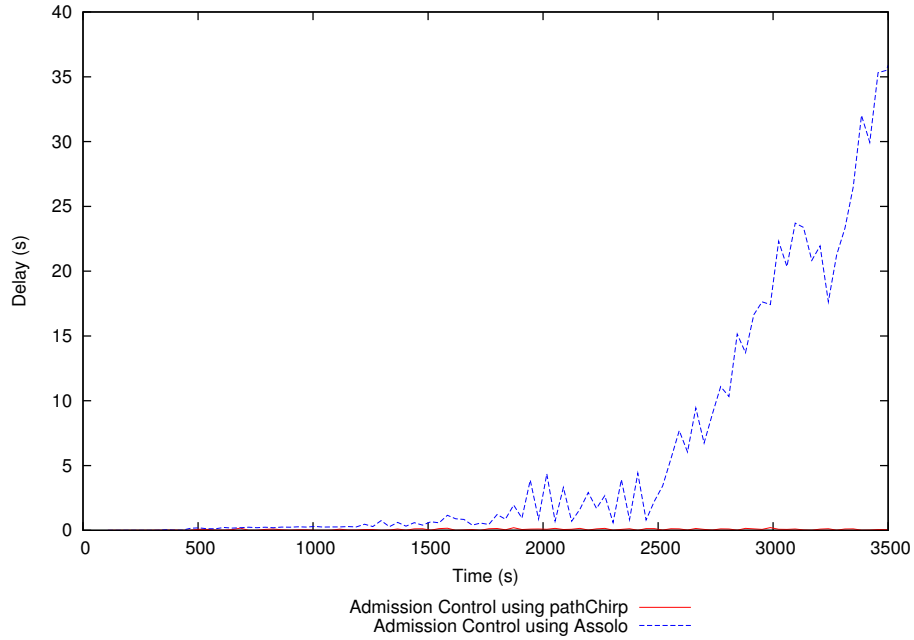

Figure 3.12: End to End Delay when using ABET based Admission Control with Assolo and pathChirp.

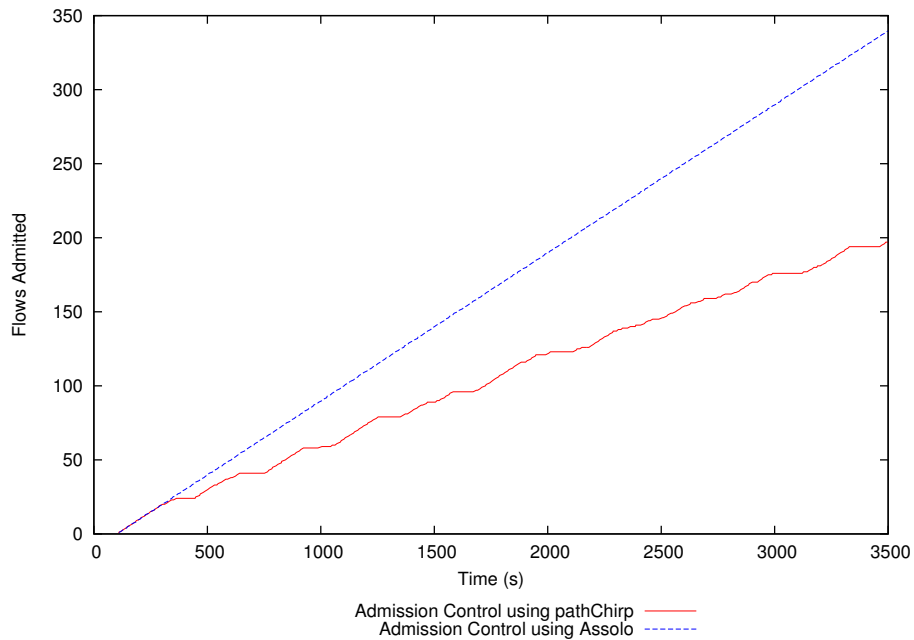

Figure 3.13: Traffic Flows admitted by ABET based Admission Control using Assolo and pathChirp.

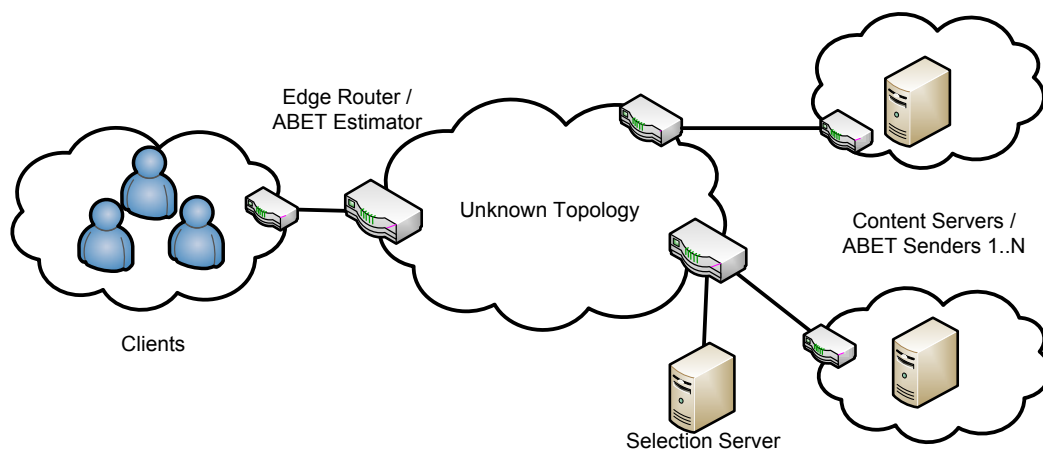

Figure 3.14: Admission Control Framework Components.

3.2.1 ABAC: Available Bandwidth based Admission Control

The IPTV admission control framework presented is, as discussed previously, concerned with ensuring the adequate delivery of content from the content servers to the clients over an intermediate topology that is not controlled by the service provider (the Internet being the most likely such topology). These content servers are the equivalent of the Video Sorting Offices (VSOs) shown in the reference logical architecture for content delivery networks, Figure 2.1. Content servers within this framework have two purposes: to serve content items and to send ABET packets along the network path of interest. These ABET packets are received by the edge router which uses them to generate an Available Bandwidth estimate. The edge router is also the point of attachment of the clients to the network.

One server in the framework, referred to as the selection server, has the sole responsibility for collating the Available Bandwidth estimates for each path and making the decision on whether or not to accept a new request. This server works in conjunction with any number of content servers in the framework. This type of physical architecture is similar in structure to that presented in Yu *et al.* (2006). The selection server can be located anywhere within the network and if deployed in a production environment, would require suitable redundancy features (e.g. load balanced servers or backup servers that can be used in a fail over). This would help to prevent the selection server from being a single point of failure for the IPTV system. It is assumed that each content server contains a complete library of all the content items, allowing any item

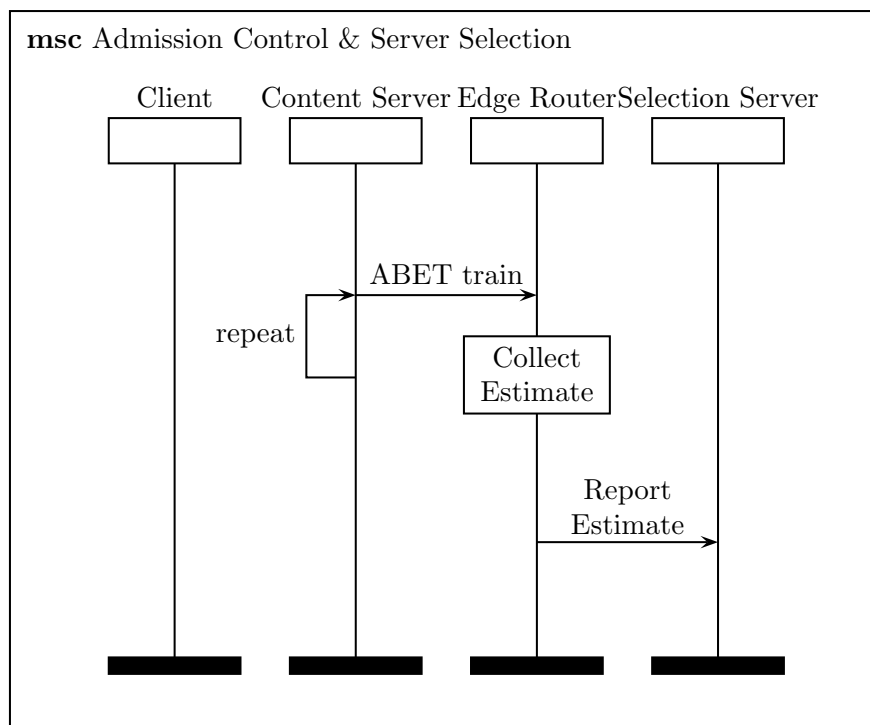

Figure 3.15: IPTV Admission Control Component Interaction.

to be served from any server. Figure 3.14 depicts this architecture while Figures 3.15 and 3.16 shows how the components interact with each other.

In Figure 3.15, the content server sends an ABET train to the edge router at regularly defined intervals. The edge router uses this packet train to generate an estimate of the available bandwidth, and reports this to the selection server. Independently of this, when a request is generated, it goes from the client to the selection server. As can be seen in Figure 3.16, the selection server makes a decision to accept or reject the request (based on the algorithms discussed in the following sections). A rejection is reported to the client, whereas an acceptance is delegated to the appropriate content server and the content is served.

The server selection / admission control algorithm bases its decision to accept or reject a new request for a content item type on whether any of the content servers have the available bandwidth required on their path to the client. Assume there are I individual types of content made available by the service provider. Let $i = 1, \dots, I$ denote an arbitrary type of content item. Let $p(i)$ denote the peak bandwidth per second

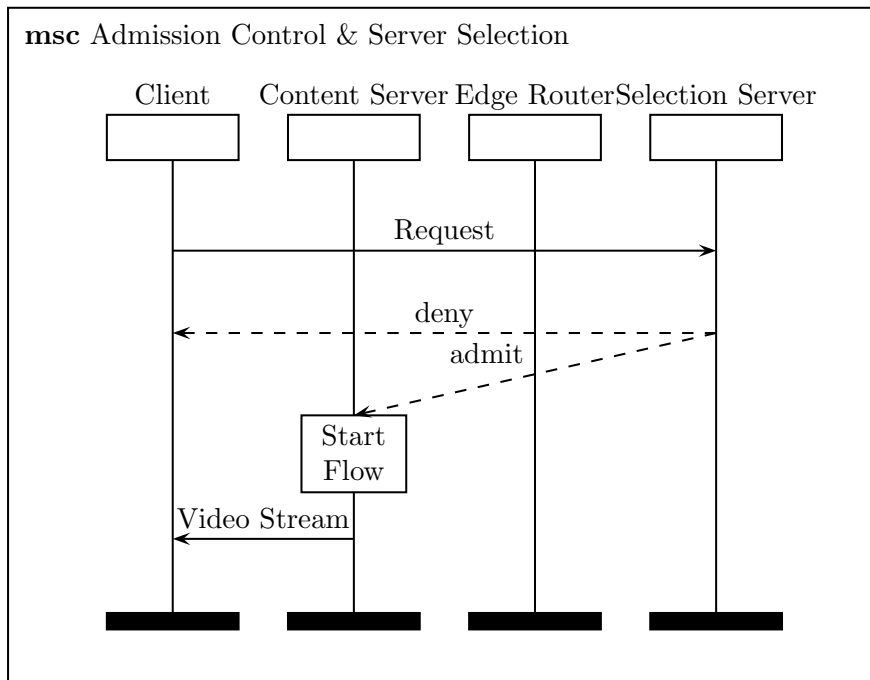

Figure 3.16: IPTV Admission Control Component Interaction.

Table 3.9: Notation used for ABAC algorithm.

Notation	Description
I	The number of individual types of content item offered by the service provider.
i	A particular content item type.
$p(i)$	The peak bandwidth per second required by item type i .
J	The number of content servers, each of which hosts all content items.
j	One of the J content servers.
$B_{jd}(t - t', t)$	The bandwidth used by flows admitted in the last t' interval for content server j to destination d .
$(t, t + t')$	The interval of time for which recently admitted flows are remembered.
$\hat{B}_{jd}(t)$	The Available Bandwidth estimate between content server j and destination d as reported by the ABET at time t .

required by item type i . Assume that the service provider maintains J content servers, each with a single dedicated egress link to the core network. Let $j = 1, \dots, J$ denote an arbitrary content server. Let $\hat{B}_{jd}(t)$ denote the estimate of available bandwidth between content server j and edge router d as calculated at time t .

Due to the reactionary nature of end to end Available Bandwidth estimation, it is necessary to allow for requests that have recently been accepted by the admission control process, but that have not been active long enough to have an affect on the estimates being reported by the ABET. To this end, provisioning was added to the Admission Control process. This involves reducing the estimate of the available bandwidth on the path between a particular content server and the clients by a set amount for each request that was assigned to the server in question in a particular time period.

This provisioning function $B_{jd}(t - t', t)$ has conservatively been set as allowing the expected peak throughput of an individual flow for every request that commenced with a time interval sufficient for the ABET averaging process to fully register a new flow (results from this study have shown 5 mins to be a suitable choice). It is felt this time limit should be set conservatively large if the goal is to minimise end-to-end delays for accepted flows, even if this means that some requests are denied. Algorithm 1 formalises the decision making process while Figures 3.15 and 3.16 shows the sequence of messages that control the process.

As mentioned previously, the selection server maintains an estimate of the Available Bandwidth $\hat{B}_{jd}(t)$ for the current time t of each path between content server j and edge router d . This estimate is calculated as a moving average of recent reported estimates. If only one server is listed as possessing enough bandwidth to support a request for a particular item type, then the request is accepted and allocated to that content server j^* . If there are multiple servers capable of supporting the request, j^* is assigned to be the content server with the highest available bandwidth. The final case occurs when none of the network paths have sufficient bandwidth and in this case the request is rejected. This is specified formally in Alg. 1.

3.2.2 Algorithms for Comparison

This section presents two algorithms which are used to benchmark the performance of the proposed ABET based server selection / admission control algorithm. The first is a Random selection approach (termed RAND), which accepts all requests, assigning

3.2 Using ABETs in IPTV Server Selection / Admission Control

Algorithm 1 Algorithm for Available Bandwidth based Admission Control (ABAC).

Input: $i, B_{jd}(t - t', t), \hat{B}_{jd}(t)$

Output: $(ACCEPT|REJECT), j^*$

```
1: for all content servers  $j = 1 \dots J$  do
2:   List all content servers  $\{j'\}$  for which  $(\hat{B}_{jd}(t) - B_{jd}(t - t', t)) > p(i^*)$ 
3:   if  $\{j'\} \neq NULL$  then
4:     Select  $j^* \in \{j'\} : (\hat{B}_{jd}(t) - B_{jd}(t - t', t)) = \max\{(\hat{B}_{jd}(t) - B_{jd}(t - t', t))\}$ 
5:     Return ACCEPT,  $j^*$ 
6:   else
7:     Return REJECT
8:   end if
9: end for
```

them at random to one of the content servers. The second, specified in Algorithm 3, is given a static value for the level of bandwidth available to it on paths to each content server. When a new request arrives it assesses, based on its knowledge of previously accepted requests, if one or more of the paths have sufficient bandwidth to carry the flow. If they do the request is accepted and assigned to the path with the highest level of unassigned bandwidth. Notation is consistent with that used in Table 3.9 and extended to include TOT_j the static total bandwidth at content server j .

Algorithm 2 Algorithm for Random Server Selection (RAND).

Output: j^*

```
1:  $j^* = random(1, J)$ 
```

3.2.3 Experimental Setup

The simulation study was performed using the OPNET Modeler [OPNET Modeler \(2013\)](#) simulation environment. Figure 3.17 shows the modelled topology used to validate the use of Available Bandwidth based admission control. In this scenario there is three different content servers, all of which have the same video content. There is also

3.2 Using ABETs in IPTV Server Selection / Admission Control

Algorithm 3 Algorithm for Admission Control using Static Total Bandwidth (SBAC).

Input: $i, B_{jd}(t - t', t), TOT_j$

Output: $(ACCEPT|REJECT), j^*$

- 1: List all content servers $\{j'\}$ for which $(TOT_j - B_{jd}(t - t', t)) > p(i^*)$
 - 2: **if** $\{j'\} \neq NULL$ **then**
 - 3: Select $j^* \in \{j'\} : (TOT_j - B_{jd}(t - t', t)) = \max\{(TOT_j - B_{jd}(t - t', t))\}$
 - 4: Return $ACCEPT, j^*$
 - 5: **else**
 - 6: Return $REJECT$
 - 7: **end if**
-

a management server that is responsible for receiving requests and determining which content server should service the request. The flows were actual video traces taken from [Seeling *et al.* \(2004\)](#). Video lengths were distributed as per the characteristics reported in [Cheng *et al.* \(2007\)](#). For the purposes of control and analysis, the concentration in this section is on requests arriving into the network from a single access point. The topology between the client nodes access point and the content servers is assumed to be a stable topology that is not controlled by the VoD system provider.

In this experimental setup, this topology consisted of Fast Ethernet (100Mbps) links that connected each of the content servers to the client nodes. Background traffic loads were added to the paths between the content servers and the access point of the clients. The number of links between each content server and the edge router was kept equal at 2 hops, again for the purpose of experimental control. OPNET's traffic generators were used to create background loads of 70Mbps, 65Mbps, and 60Mbps on the paths of content servers A, B and C respectively. This traffic generator was configured to distribute the packet sizes with an average of 576 bytes, which is the Maximum Transmission Unit (MTU) size for IPv4.

3.2.4 Steady State Network

To examine the steady state behaviour of the network, a new request was generated from the group of client nodes using an exponential distribution with an average of 10

3.2 Using ABETs in IPTV Server Selection / Admission Control

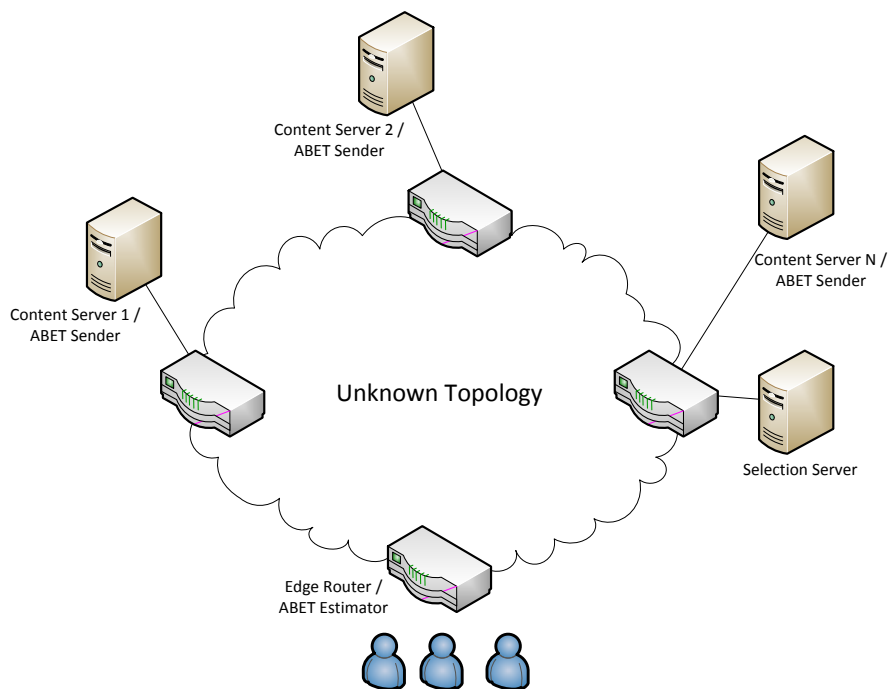

Figure 3.17: Server Selection / Admission Control Experimental Topology.

seconds. The performance of the system in terms of end to end delay and flows accepted was examined. A comparison between the proposed system (ABAC), a random server selection approach (RAND) and the approach outlined in Algorithm 3 (SBAC) is presented. As can be seen by the comparison between the end to end delays presented in Figure 3.18, the random server selection approach is least suitable when the onus is on maximising the Quality of Service.

For the steady state system, the delay experienced by the ABAC approach was better than that of the Static Admission Control approach. In this experiment, the SBAC approach was configured with a static knowledge of the bandwidth that was available on each path. However, the deliberate prioritization of end to end delay over flows accepted means that the ABAC approach with the settings decided upon accepts fewer requests (Figure 3.19) than SBAC. By altering these parameters, it is possible to increase the flows accepted to match that of SBAC.

3.2 Using ABETs in IPTV Server Selection / Admission Control

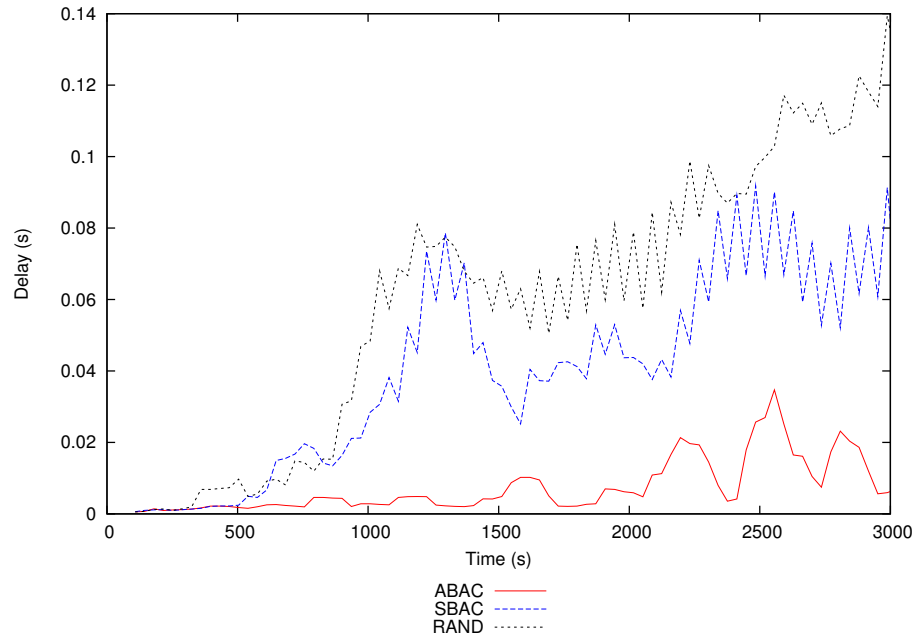

Figure 3.18: End to End Delay of all AC approaches for Steady State Network.

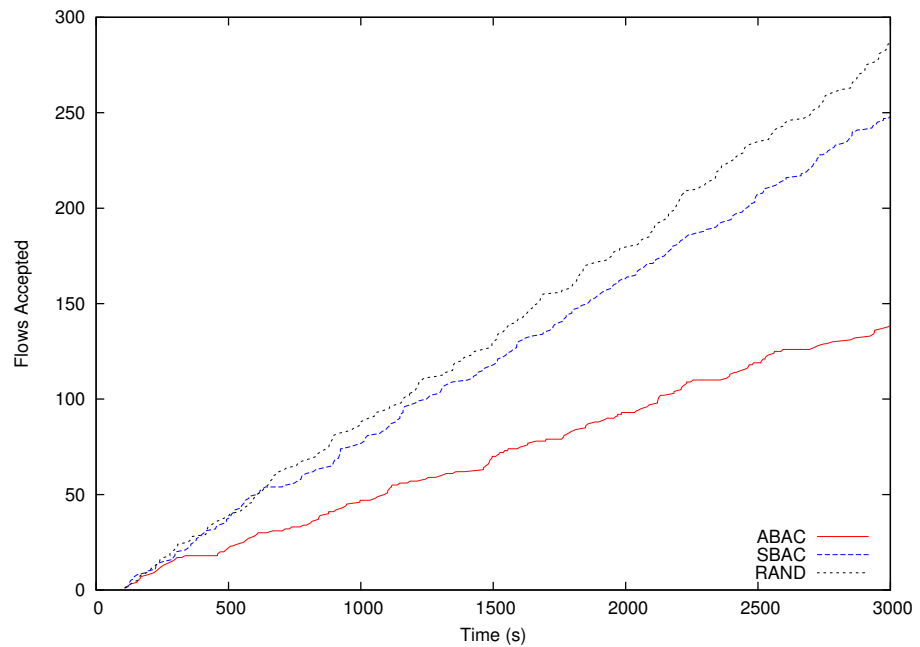

Figure 3.19: Requests admitted of all AC approaches for Steady State Network.

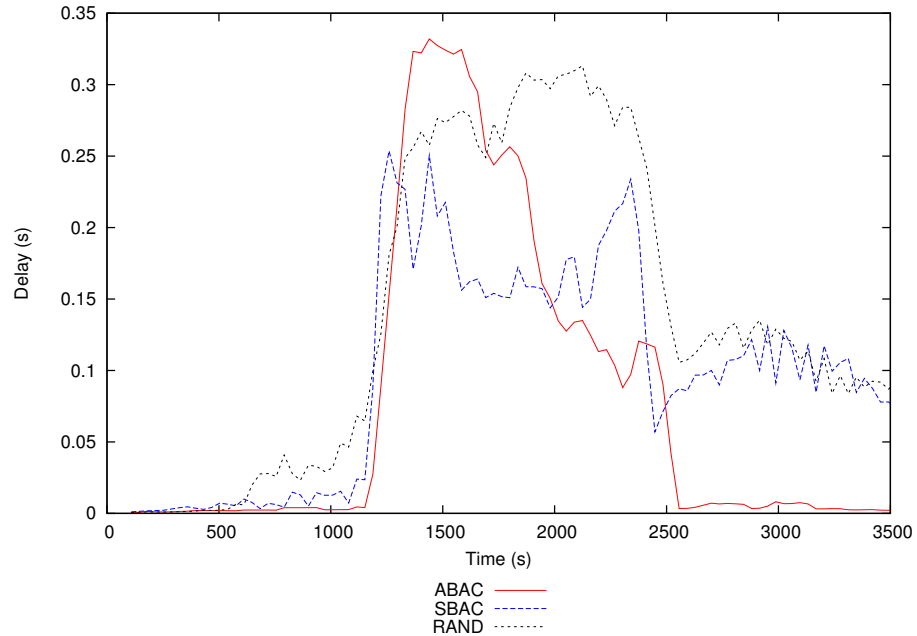

Figure 3.20: End to End Delay of all AC approaches for Increased Background Network.

3.2.5 Increased Background Network

A change in the quality/availability of the underlying network paths is a very real possibility in networks like this. Therefore, it is important to examine how the system would react to a degradation of the resources available to it. This was examined by analysing the approaches in question when the content server with the most favourable path in terms of available bandwidth becomes the path with the least amount of bandwidth available to it. A step change was introduced to the background traffic to increase the load to 90Mbps between 1200 seconds and 2400 seconds. The delays experienced by each of the approaches can be seen in Figure 3.20.

The Random server selection approach is the least capable of dealing with this degradation of network conditions. It simply keeps admitting new flows and the end to end delay experienced continues to grow. The SBAC approach shows increased delay whilst the poorer network conditions are present, and thus shows its weakness by being unable to lessen the amount of flows accepted on that particular path. The ABAC approach can be seen to be high at the beginning of the period of increased background load. This is because it had previously been favouring this path, resulting

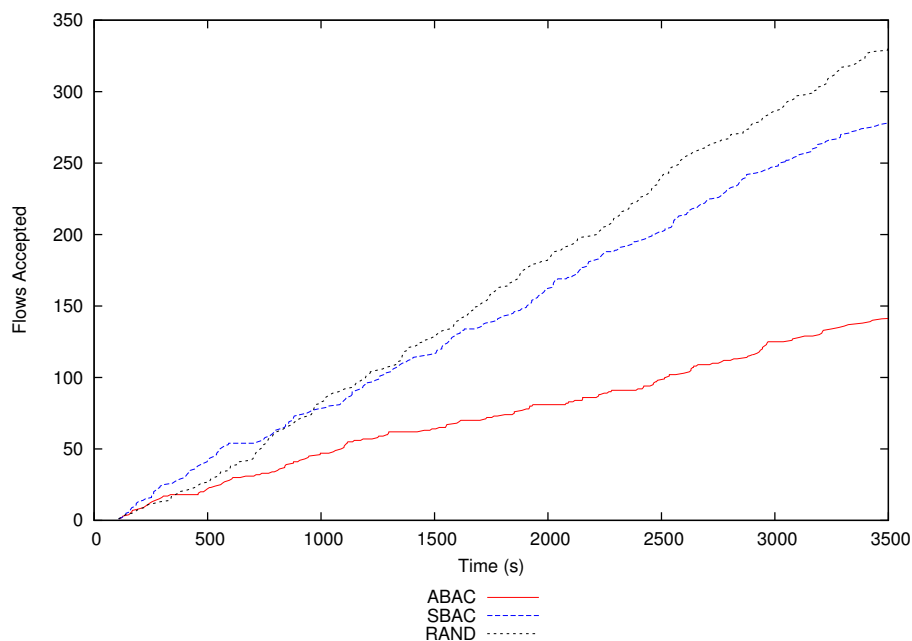

Figure 3.21: Requests admitted of all AC approaches for Increased Background Network.

in many flows being requested by Server C. As the ABET recognises the new bandwidth available on the path, and flows previously allocated to this path are completed, the delay returns to that of the steady state system. The other two approaches do not return to their previous levels of end to end delay as a build up of traffic has occurred due to flows allocated onto path C while the increased load was present.

The varying amount of flows admitted by each of the approaches (as shown in Figure 3.21) highlights their varying ability to cope with network conditions. RAND indiscriminately admits everything. ABAC can be seen to admit significantly less than SBAC and this difference is mostly accounted for by the time period containing the increased background.

Figure 3.22 shows the cumulative amount of requests accepted for the ABAC approach in both the steady state and increased background experiments. Figure 3.23 shows the same for the SBAC approach. It can be seen that immediately after the commencement of the increased background traffic (at 1200 seconds), the ABAC system starts to deal with the new conditions by admitting less requests onto the network. In contrast, SBAC is unable to do likewise, and thus suffers from the greater end to end

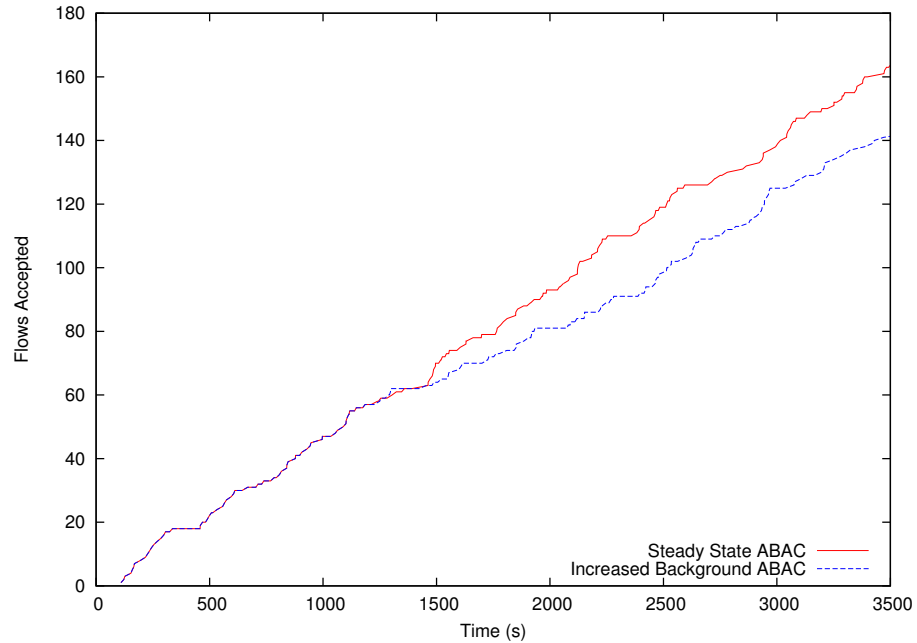

Figure 3.22: Requests admitted by ABAC.

delay shown previously.

The utilization of the path that experiences the increased background traffic can be seen for both the ABAC and SBAC approach (Figures 3.24 and 3.25). It can be seen that the SBAC approach overloads the path for the duration of the higher background traffic. ABAC however can be seen to begin recovering sooner than this. This is due to the ABAC approach no longer selection this server as soon as the ABETs report of lower Available Bandwidth is processed.

3.3 Summary

The purpose of this chapter has been to address the first research question. This was firstly achieved by undertaking an investigation and comparison into some popular ABETs. The characteristics and parameters of these ABETs were discussed, with a focus on how these parameters affect performance.

Following this, an investigation was presented into the use of these ABETs to provide available bandwidth estimates that are used as the basis of the server selection / admission control process. It was determined that admission control requires up-

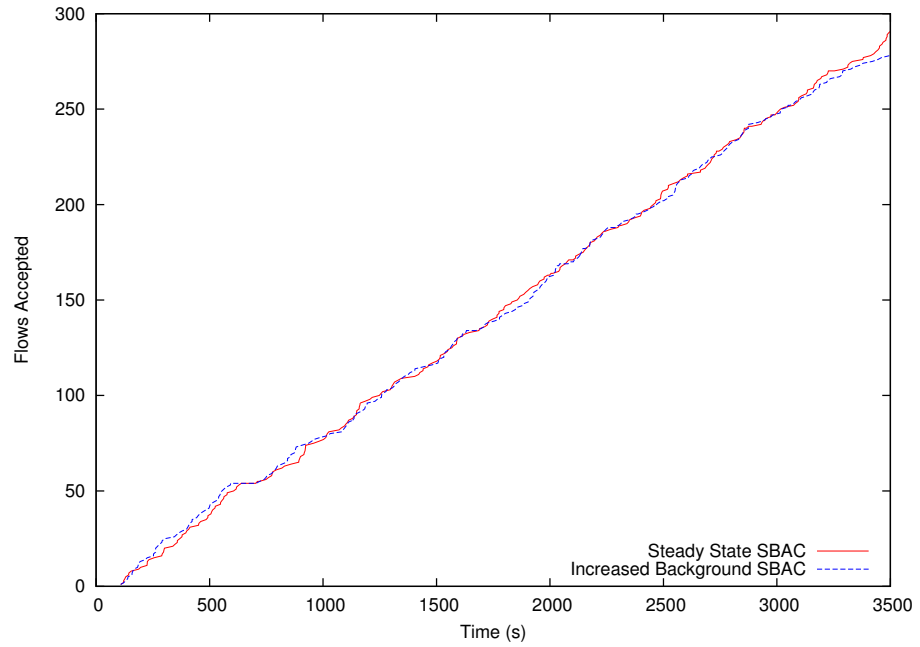

Figure 3.23: Requests admitted by SBAC.

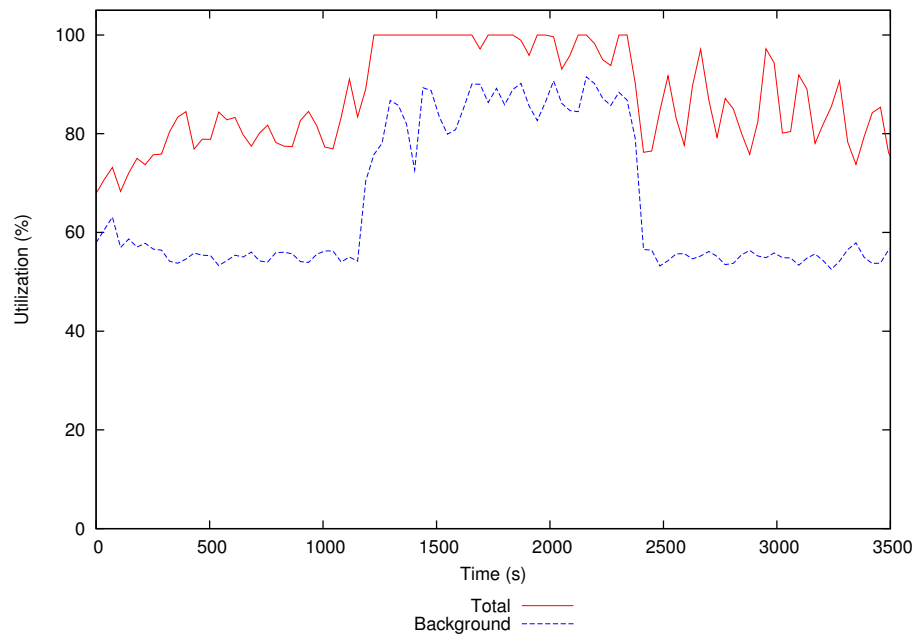

Figure 3.24: Loaded path (path C) utilization during ABAC Increased Background.

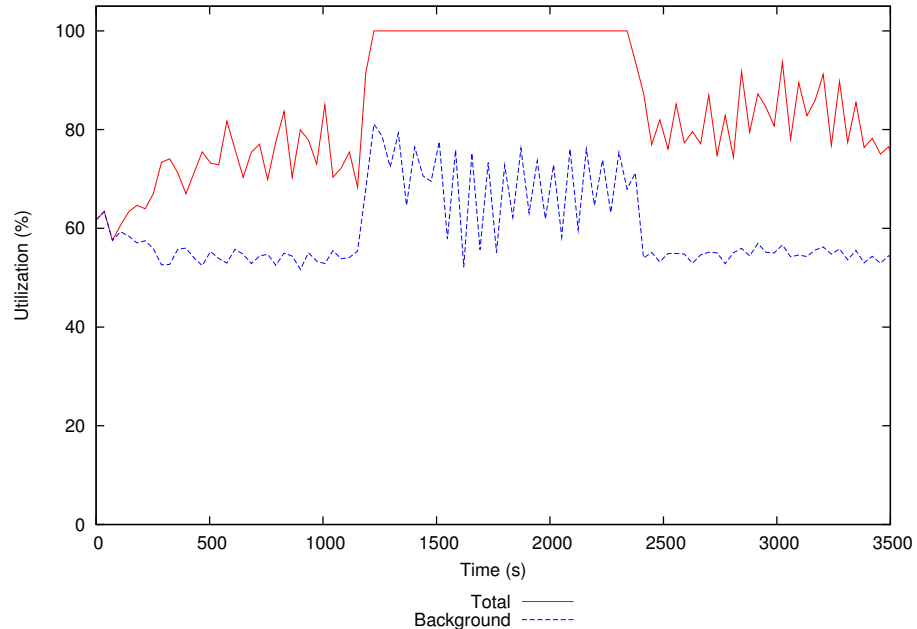

Figure 3.25: Loaded path (path C) utilization during SBAC Increased Background.

to-date knowledge of bandwidth availability, therefore any ABET employed must be parameterised for acceptable performance in the given deployment scenario.

Of the ABETs examined, pathChirp is the most appropriate for server selection / admission control. It is believed this is due to the fact that pathChirp initially probes at the lower rates of its operational range, so it is more sensitive to changes in available bandwidth. On the other hand, Assolo initially probes at rates in the middle of its operational range, so it does not adjust quickly to increases in background traffic, with the result that it admits too many requests in periods of high demand, and the inaccuracy levels of eChirp meant it was deemed unsuitable.

The ABET-based server selection / admission control algorithm exhibits the ability to adjust to prevailing traffic conditions, controlling the number of requests admitted when background traffic on paths to servers increases.

The main research contributions shown in this chapter are twofold: firstly, findings and guidelines were presented on the suitable deployment of an ABET for an IPTV environment. Secondly, an algorithm and distributed framework for admission control was presented. This algorithm is capable of ensuring that Quality of Service is adhered to, even in rapidly changing network conditions.

Chapter 4

IPTV Resource and Revenue Management

Research question two is investigated in this chapter. The research work presented in the subsequent sections builds on the research carried out in Chapter 3 by examining the resource and performance benefits that can be gained by the IPTV service provider when incorporating Available Bandwidth estimation. More specifically, it looks at benefits that can be garnered when performing content distribution (amongst data centres and servers) and content delivery (from server to client) within the IPTV system. The research findings presented here have been published as the following two papers: Meskill *et al.* (2013) and Meskill *et al.* (2012).

This chapter first looks at content distribution at an intra service provider level. It presents and discusses an algorithm for adaptive content replication that leverages Available Bandwidth estimations in conjunction with a smart decision making process for selecting content to replicate. The resultant algorithm operates in a manner that is targeted, both in terms of what content it replicates and also where that content is replicated to. Such a precise targeting is beneficial to the IPTV service provide as it allows an increase in the requests serviced to occur (which improves revenue), as well as allowing a controlled expansion / reduction in resources that are in use (which enables more efficient cost management).

After presenting the benefits that Available Bandwidth estimation can provide for content distribution, the focus in addressing this research question turns to content delivery, and the chapter continues with a discussion of how to maximise the revenue

that can be generated when providing content to clients, specifically by using Available Bandwidth information to determine if the cost of servicing a request is a worthwhile cost for the service provider to absorb.

Finally, this chapter concludes with a summary of the research presented and its applicability to research question two. The core contributions of this chapter to the thesis are also highlighted.

4.1 Content Replication

In this section, the benefits of using an adaptive content replication process to replicate content across multiple storage servers are illustrated. For example in cases where particular content items are very popular (for example following the release of a blockbuster movie) the increasing volume of requests will be detected and content replicated to multiple storage servers from where it can be streamed under the control of a server selection / admission control process.

Alternatively, in cases where the network links connecting users to the IPTV service provider's "base" server become congested, content can be replicated to other servers to ensure that users' requests can be admitted and receive adequate quality-of-service. This ability to replicate and remove content as required can significantly aid in increasing requests accepted. It also has the advantage of improving costs by ensuring efficient use of resources.

4.1.1 Adaptive Replication Algorithm

Figure 4.1 shows an abstracted scenario for an Over-The-Top IPTV service provider. This scenario consists of servers which are geographically distributed. The scenario is based upon the IPTV service provider having its own storage capabilities and a server selection / admission control server at its own base of operations and having remote and geographically distributed content servers that can be brought online by the service provider as required. The remote servers have a monitoring capability in the form of available bandwidth estimation tools that can be configured to use packet probes to estimate the available bandwidth between their network point of attachment and the network points of attachment of various user groups.

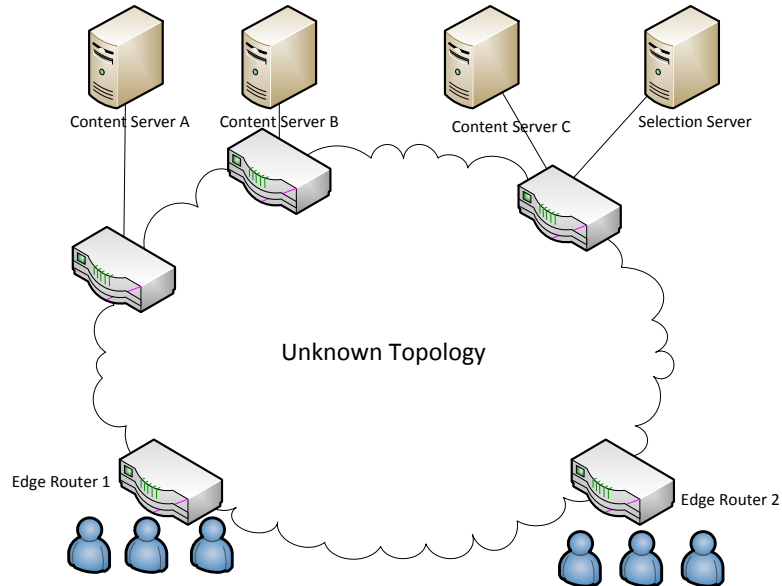

Figure 4.1: Simplified IPTV Content Distribution Scenario.

IPTV clients request streaming of content items from the selection server. As in the previous chapter, the selection server decides to admit the request if at least one content server that currently contains the item estimates that there is enough bandwidth between it and the user's point of attachment to serve the request. If more than one content server is capable, the server with the most available bandwidth is chosen. Rejections occur when there is not enough bandwidth available on any path to ensure servicing the request with adequate quality-of-service.

With the adaptive replication algorithm, items are chosen for replication based on the amount of rejections they have experienced in the preceding control interval. If the amount of rejections for an item (as a percentage of the overall requests) is greater than a set threshold, then that item is marked for replication to another content server if a server is available in the system to host it.

Similarly, if an item has experienced an amount of rejections in the last time interval that is less than a pre-determined minimum amount, then it is removed from one of the content servers hosting it; this prevents the situation where revenue is spent on operating servers that are under utilised.

The content replication process presented here takes into account the volume of requests/rejections for particular content item classes as well as end-to-end available

bandwidth estimates provided by storage providers.

Table 4.1: Notation for Adaptive Content Replication Algorithm.

Notation	Description
i	A particular content item group.
I	The number of content item groups offered by the service provider.
s_i	The storage capacity required for content item group i .
$(t - t', t)$	The time interval for which requests and rejections are recorded.
$q_{tot}(t - t', t)$	Total number of requests for content items arrived during $(t - t', t)$.
$r_i(t - t', t)$	Number of requests for content item group i that rejected during $(t - t', t)$.
RF_i	The current rejection rate of content item group i .
J	The number of available content servers.
j	A particular content server.
S_j	Storage capacity currently available on content server j .
d	A particular edge router.
D	The number of edge routers.
\hat{A}_{jd}	The available bandwidth estimate between content server j and edge router d .
$\{i_j\}$	The set of content item groups stored on content server j .
$n(i)$	The number of servers currently storing content item group i .
RF_{min}	Minimum threshold for acceptable rate of rejections.
RF_{max}	Maximum threshold for acceptable rate of rejections.

Algorithm 4 formally describes the adaptive content replication algorithm while the notation used is described in Table 4.1. Each time it executes the algorithm loops through the content item groups and for each content item group loops through the number of content servers twice. Therefore the algorithm is of complexity $\mathcal{O}(n^2)$. As the algorithm groups a possibly large number of content items in to a relatively small number of content item groups, it is believed the time complexity of the algorithm would not be a significant issue.

Algorithm 4 Adaptive Content Replication Algorithm

```

1: for  $i = 1 : I$  do ▷ Calculate Rejection Factor
2:   Set  $RF_i = r_i^{(t-t',t)} / q_{tot}(t - t', t)$ 
3: end for

4: for all  $i \in \{i\}$  in order of decreasing  $|RF_i|$  do
5:   if  $RF_i < RF_{min}$  &  $n(i) > 1$  then ▷ Remove Unrequired Replications
6:     for  $j = 1 : J$  do
7:       if  $i \in \{i_j\}$  then
8:         Remove  $i$  from  $\{i_j\}$ 
9:         Reduce  $n(i)$  by 1
10:        Increase  $S_j$  by  $s_i$ 
11:        Break ▷ Remove from only 1 content server at each iteration
12:      end if
13:    end for

14:   else if  $RF_i > RF_{max}$  &  $n(i) < J$  then ▷ Assign New Replications
15:     for  $j = 1 : J$  do
16:       if  $i \notin \{i_j\}$  &  $s_i < S_j$  &  $j = \max\{\sum_{d=0}^D \hat{A}_{jd}\}$  then
17:         Replicate  $i$  to  $\{i_j\}$ 
18:         Increase  $n(i)$  by 1
19:         Reduce  $S_j$  by  $s_i$ 
20:         Break ▷ Replicate to only 1 content server at each iteration
21:       end if
22:     end for
23:   end if
24: end for

```

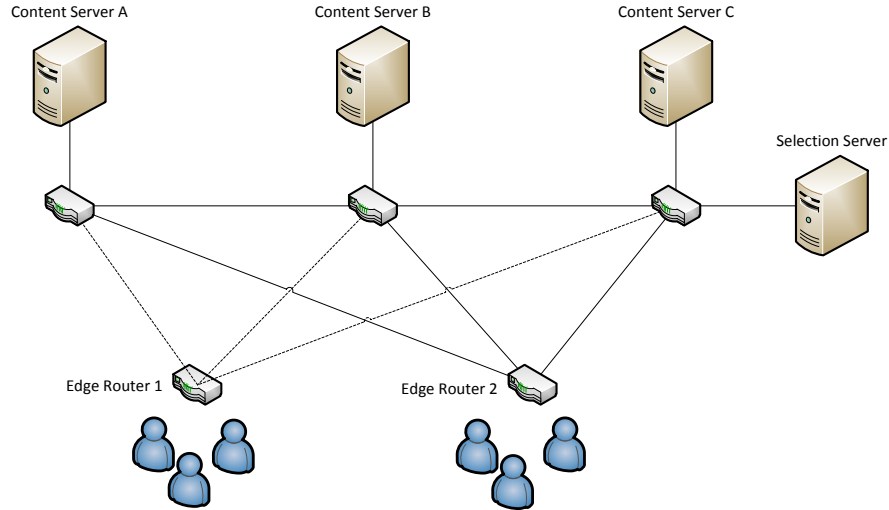

Figure 4.2: Content Replication Experimental Network Topology.

Table 4.2: Link Available Bandwidths.

Server	Edge Router	Available Bandwidth (Mbps)
A	1	50
B	1	40
C	1	70
A	2	50
B	2	40
C	2	70

4.1.2 Experimental Setup

The results¹ of a simulation study of the operation of the adaptive content replication process are now presented. The modelled network topology used is depicted in Fig. 4.2. It consists of three content servers and a selection server. Background loads have been added to the paths to create the steady state mean available bandwidth profiles shown in Table 4.2. The base content server in the topology is server C and there are two other content servers (servers A and B) to which content items can be replicated to under the control of the adaptive content replication algorithm. Requests come into the network from two points of attachment (Edge Routers 1 and 2).

¹Results presented are averaged from 10 independent simulation runs.

The items in the IPTV content library have an average length of 20 mins. Replications are triggered every 600 seconds. Individual content items are grouped into 15 content classes (treated as single units for replication purposes) and model request arrivals at different rates for groupings of 5 content item classes. Overall, requests occur in steady state at an exponentially distributed rate of 0.08/s. To examine the performance of the replication algorithm, two scenarios were developed: where there was a significant increase in the rate of requests, and one where there was a significant degradation in network conditions.

Table 4.3: Notation for Randomly Selected Content Replication Algorithm.

Notation	Description
i	A particular content item group.
I	The number of content item groups offered by the service provider.
$(t - t', t)$	The time interval for which requests and rejections are recorded.
$q_{tot}(t - t', t)$	Total number of requests for content items arrived during $(t - t', t)$.
$r_i(t - t', t)$	Number of requests for content item group i that rejected during $(t - t', t)$.
$r_{tot}(t - t', t)$	Total Number of requests that were rejected during $(t - t', t)$.
J	The number of available content servers.
j	A particular content server.
S_j	Storage capacity available on content server j .
s_i	The storage capacity required for content item group i .
$\{i_j\}$	The set of content item groups stored on content server j .
$n(i)$	The number of servers currently storing content item group i .
i^*	List of content item classes that can be replicated.
R_{min}	Minimum threshold for acceptable rate of rejections.
R_{max}	Maximum threshold for acceptable rate of rejections.

To further illustrate the benefit of using this adaptive content replication process, a comparison is undertaken in each of the scenarios with an approach that uses a random replication process, formally specified in Algorithm 5 and Table 4.3. This comparison algorithm operates by monitoring the rejections in the system and when a threshold is reached, randomly selecting a subset of content items classes to replicate.

Algorithm 5 Randomly Selected Content Replication Algorithm

```

1:  $r_{tot}(t - t', t) = (\sum_{i=0}^I r_i(t - t', t)) / q_{tot}(t - t', t)$     ▷ Calculate rejection rate in time  $t'$ 
2:  $i^* = \{i\}$     ▷ Create list of content classes that can be replicated

3: if  $r_{tot}(t - t', t) > R_{max}$  then    ▷ Replicate if rejections exceed threshold
4:   for  $j = 1 : J$  do
5:     while  $S_j > \min\{s_i\}$  do
6:       Randomly Select Content Item group  $i$  from  $i^*$ 
7:       if  $i \notin \{i_j\} \ \& \ s_i < S_j \ \& \ n(i) = 1$  then
8:         Replicate  $i$  to content server  $j$ 
9:         Increase  $n(i)$  by 1
10:        Reduce  $S_j$  by  $s_i$ 
11:        Remove  $i$  from  $i^*$ 
12:       end if
13:     end while
14:   end for

15: else if  $r_{tot}(t - t', t) < R_{min}$  then    ▷ Remove replications
16:   for  $j = 1 : J$  do
17:     for all  $i \in \{i_j\}$  do
18:       if  $n(i) > 1$  then
19:         Remove  $i$  from  $\{i_j\}$ 
20:         Decrease  $n(i)$  by 1
21:         Increase  $S_j$  by  $s_i$ 
22:       end if
23:     end for
24:   end for
25: end if

```

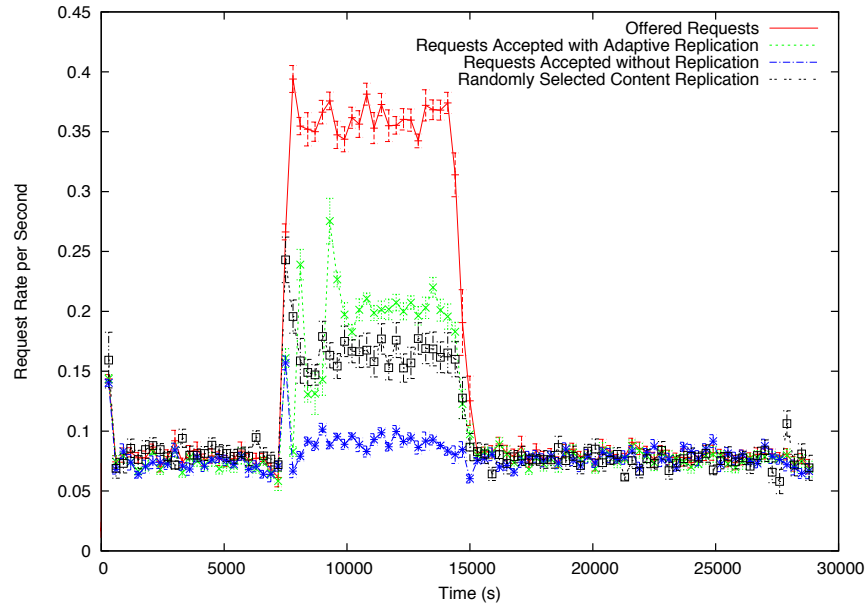

Figure 4.3: Requests Accepted during a step increase in request arrival rates.

4.1.3 Increased Requests Results

To test the replication algorithm, a step change in the rate of requests was introduced. Starting at 7200 seconds, the request rate of one of the three sub groups was increased to 0.35 requests per second, with exponentially distributed inter-arrival times. Figure 4.3 shows the rate of accepted requests for the situations where adaptive and random replication occurs as well as where replication does not occur. It can be seen that the grouping of content item classes by the adaptive replication allows more requests to be accepted as it prioritizes popular content items for replication. Figure 4.4 shows the bandwidth available from each server to one of the points of attachment. As content items are replicated the algorithm accepts only the number of requests that can be satisfied given the available bandwidth to the three servers.

Initially requests are allocated to the base server. Replication of the highly requested item classes occurs to this server and admission control and server selection is performed based on the path with the most available bandwidth. As the higher request rate is maintained, the storage provider informs the IPTV service provider that the paths from both the base server and server B have become degraded and another server, server C is used for content replication. When the step change in the rate of requests is completed,

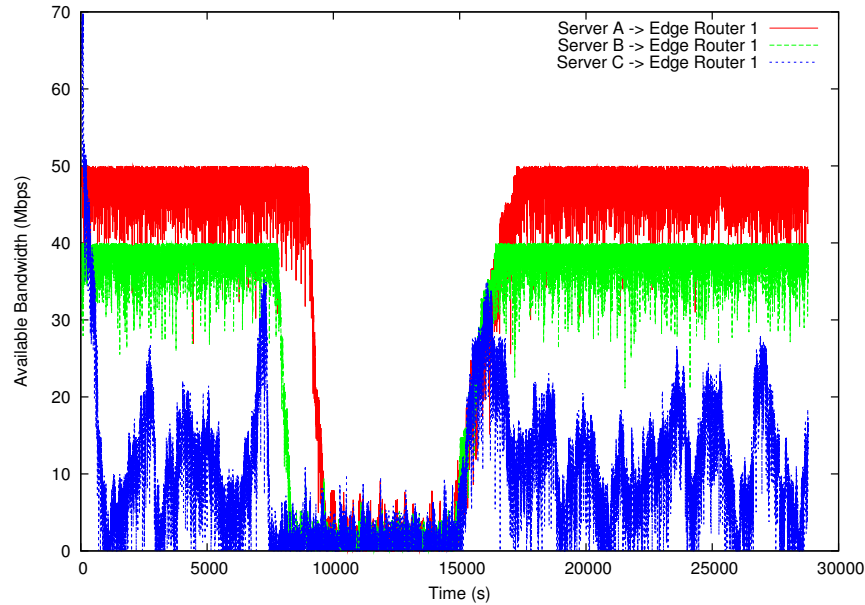

Figure 4.4: Bandwidth utilisation for adaptive replication during a step increase in request arrival rates.

the decrease in request rejections is detected and content is removed from the servers A and B, thus prevent unnecessary utilisation of resources (and associated cost), as shown in Figure 4.5.

For the Random algorithm (Figure 4.5(a)) a randomly selected set of content items is replicated to each of the servers when the overload is detected, and removed once it abates. This can be compared to the adaptive content replication algorithm (Figure 4.5(b)) where the content item classes with high request rates are first replicated to server B, then to server A, and removed once the step increase abates.

It is apparent that intelligently replicating content in times of high utilization allows the IPTV service provider accept more requests overall, while maintaining the quality of the accepted requests. It can also be seen that this approach helps in the efficient use of resources as only currently popular content is replicated, thus any resources deployed on additional servers are actively being used and providing value.

4.1 Content Replication

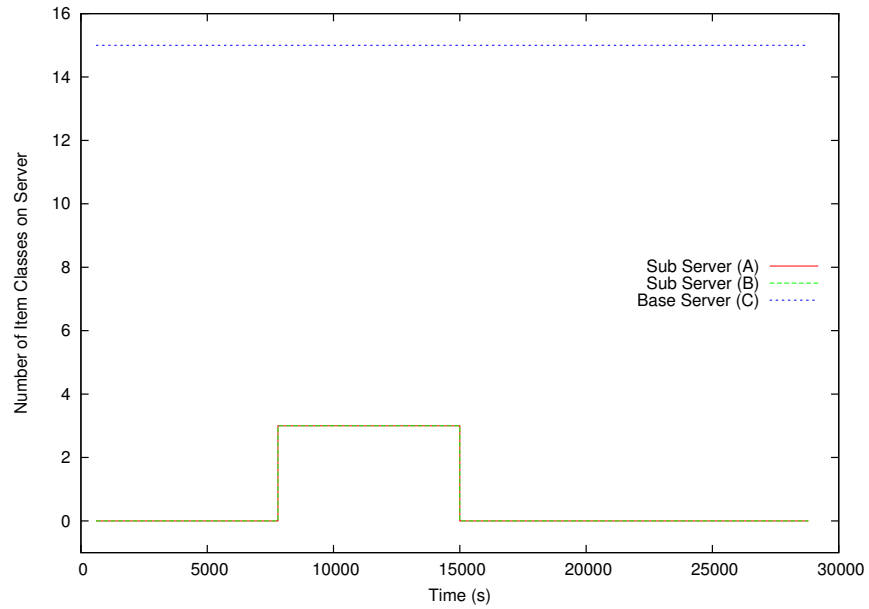

(a) Random Replication.

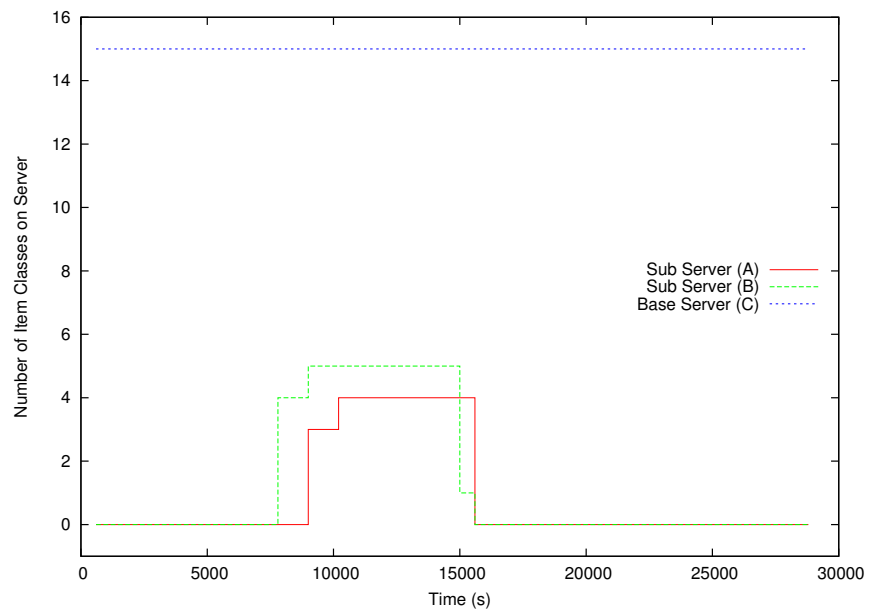

(b) Adaptive Replication.

Figure 4.5: Server content item class occupancy during a step increase in request arrival rates.

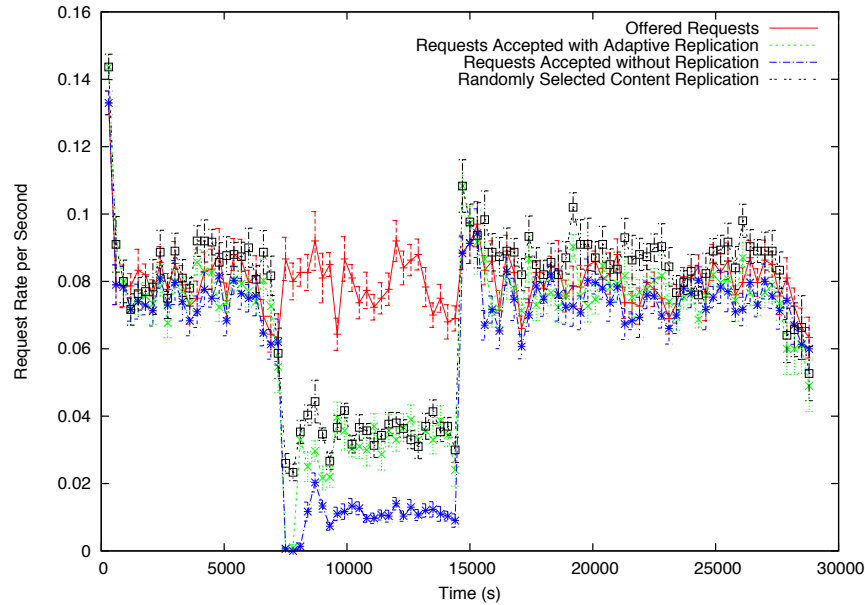

Figure 4.6: Requests accepted during increased background traffic on paths to two of the three content servers.

4.1.4 Increased Background Results

If there is an increase in the background traffic load in the network, fewer requests can be admitted by the selection server if users' quality-of-service is to be maintained. In this case the ability to replicate content to other less congested locations can help maintain the revenue generated by accepting requests. To examine the performance of the replication approaches in such a scenario, the rate of requests was kept at its steady state throughout but a step increase in the background traffic on the network paths between the edge routers and two of the three storage servers was modelled. Table 4.4 shows the changed available bandwidths that are available during this time period.

Figure 4.6 shows the requests accepted for this scenario. Reduced bandwidth leads to increasing rejection rates, which triggers replication of content items. Requests are then only accepted for content items hosted at the server to which there is sufficient available bandwidth. The benefit shown here is that the ability to replicate allows the system to accept requests at a rate which is more beneficial than when replication does not occur.

Figure 4.7 shows the bandwidth estimates reported for the three servers to edge

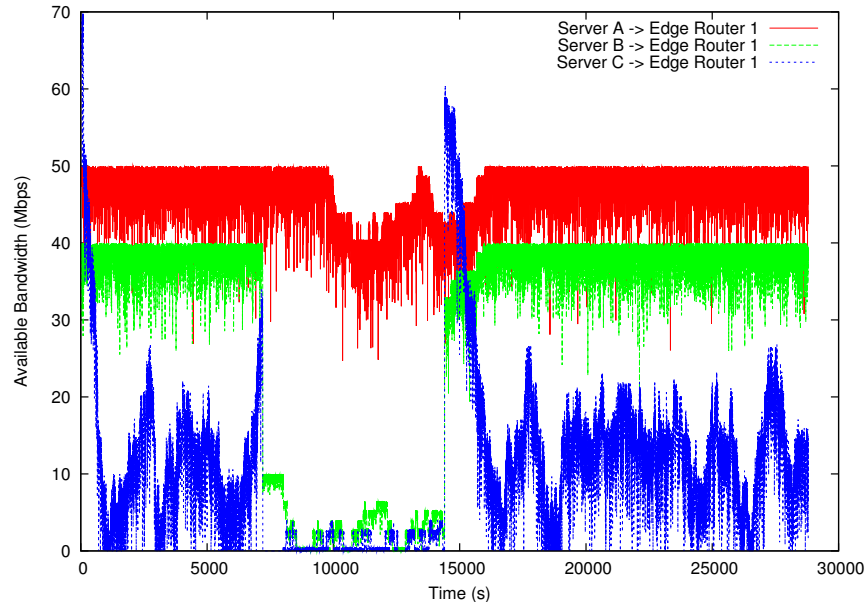

Figure 4.7: Bandwidth utilisation for adaptive replication during increased background traffic.

router 1. When the step change occurs initially, the base servers capacity to accept new requests is negligible. This leads to item classes requiring replication even though their popularity has not changed noticeably. The replication occurs to one of the sub servers which are brought online by the service provider and the capacity on the paths from this server are then allocated to requests.

As rejections in the system are still occurring, and the available bandwidth estimation is reporting a very low capacity on existing resources, another server is brought into operation and the content classes that are experiencing rejections are replicated to here also. At the end of the step change, there is an improvement in the available bandwidth conditions reported to the IPTV service provider, and the extra servers are noted to be no longer required. Therefore, the IPTV service provider removes these servers from operation as it can service requests from its base server again.

It can be seen that the random replication admits a similar amount of requests to the adaptive replication. This is due to the fact that none of the content item classes are experiencing a noticeably higher request rate than any other, and therefore the strength of grouping and replicating high frequency items is negated. The adaptive replication algorithm is still more beneficial to the IPTV provider though, as can be evidenced in

Table 4.4: Link Available Bandwidths for Increased Background Traffic Scenario.

Server	Edge Router	Available Bandwidth (Mbps)
A	1	50
B	1	10
C	1	10
A	2	50
B	2	10
C	2	10

the content item occupancy shown in Figure 4.8. This figure shows that both algorithms trigger the replication of content items, however the adaptive replication algorithm favours replication to server B as there is limited bandwidth available to serve requests from server A.

4.2 Content Delivery

In the previous section, the issue of how to efficiently distribute content was addressed. However, there is still an issue of how to deliver this distributed content from server to client in a suitably efficient manner. This efficient delivery is constrained by some necessary requirements. As mentioned previously, it is a core necessity of an IPTV service (or any multimedia service) provider to adhere to Quality of Service (QoS) targets. On top of this, as resources in an IPTV system are a finite commodity, business logic demands that these resources are used in a manner which maximizes the revenue that can be garnered by the service provider. To this end, server selection and admission control are important components to the deployment of a successful IPTV/VoD solutions.

This section addresses the use of end to end Available Bandwidth Estimation Tools (ABETs) in a selection / admission control framework in conjunction with the concept of revenue optimization [Davy *et al.* \(2008\)](#). This results in an approach to admission control and content server selection that operates in an end to end manner without the need to access measurements directly from the network topology connecting end-user points of attachment to those of one or more content servers. It is thus applicable to IPTV service providers deploying services across the public Internet. In the presented framework, revenue is maximized through prioritization of higher revenue requests and

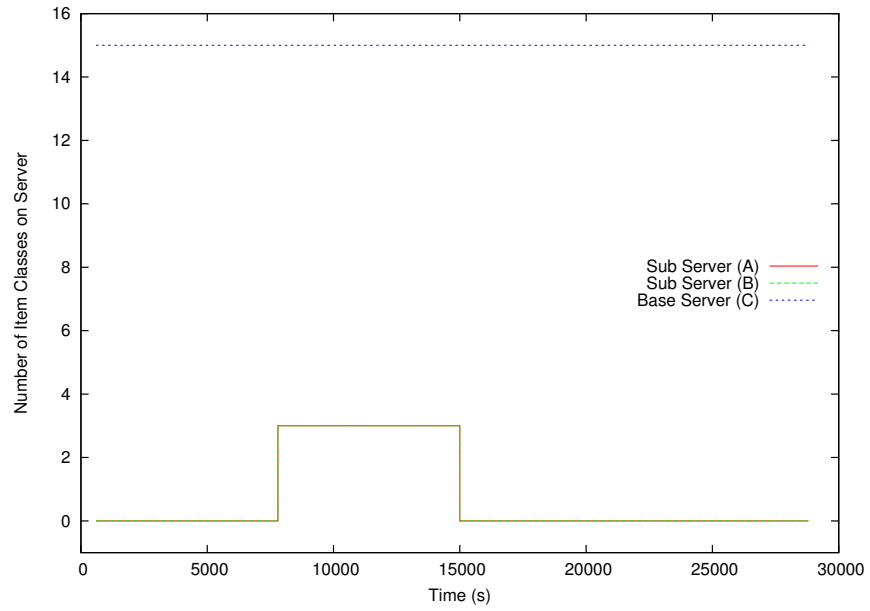

(a) Random Replication.

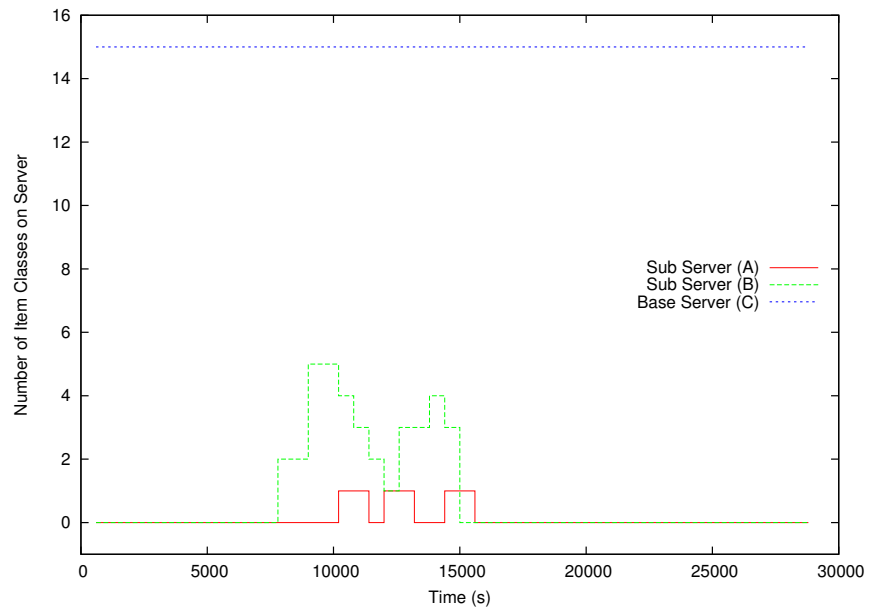

(b) Adaptive Replication.

Figure 4.8: Server content item class occupancy during a step increase in background traffic.

Quality of Service is maintained by performing server selection based on the estimated current available bandwidth of the network paths.

To accept more of these higher value requests when there is limited bandwidth (and still maintain good Quality of Service), there is a deliberate rejection of more of the lower value requests. Thus, in circumstances where a request for a lower revenue content type arrives and there is sufficient bandwidth to service it, the lower revenue content type may be rejected given the expectation that a request for a higher revenue item type will arrive imminently. This supports a business model that is focussed solely on revenue maximization, at the expense of considerations like fairness.

This raises the point that the deployment of this algorithm should be carefully considered in advance as an IPTV service provider would be exercising an opportunity cost in relation to their reputation if there was repeated rejection of lower value requests. However, the algorithm presented could be adjusted (via a weighting on the marginal utility mentioned below) to find the optimal trade-off between rejecting low value requests and the benefit to the service providers reputation from accepting these low value requests.

4.2.1 Revenue Maximising Algorithm

This algorithm extends and adapts the server selection / admission control algorithm, ABAC, presented in Chapter 3. It also uses Available Bandwidth estimates but the decision making is more complex as it takes into consideration the revenue that would be generated and the costs that would be incurred if the flow were to be accepted, as well as the probability of future requests for flows of all priorities. This algorithm is now explained in more detail.

Table 4.5: Notation for REVMAX Admission Control Algorithm.

Notation	Description
I	The number of individual types of content item offered by the service provider.
i	A particular content item type.
$p(i)$	The peak bandwidth per second required by item type i .
$r(i)$	The amount of revenue generated by accepting item type i .
T_i	The duration in seconds of flows associated with the streaming of item type i .

Continued on next page

Table 4.5 – continued from previous page

Notation	Description
J	The number of content servers, each of which hosts all content items.
j	One of the J content servers.
$(t, t + t')$	The time interval for which all currently accepted flows are expected to remain active
$q_i(t - t', t)$	The number of requests for item type i during the time period $(t - t', t)$.
$n_i(t, t + t')$	The number of requests for item type i that have been provisionally allocated by the algorithm.
$u_i(t, t + t')$	The marginal utility of accepting a request for item type i during interval $(t, t + t')$.
i^*	The item type to which the flow admission request relates.
d	The destination node that is the source of the request for item type i
$\hat{B}_{jd}(t)$	The available bandwidth estimate between content server j and destination d as computed at time t
$v(i)$	The marginal cost associated with provisional allocation of an item type i .
$\delta_i(t, t + t')$	The marginal utility per marginal cost of item type i .
$\pi_i(t, t + t')$	Variable used to calculate probability of arrivals of an item type assuming a poisson arrival process, within each iteration of the algorithm.
$\Pi_i(t, t_t')$	Variable used to calculate probability of arrivals of an item type assuming a poisson arrival process, within each iteration of the algorithm.

A Video on Demand content library can be expected to contain in the order of hundreds or thousands of different content items. The algorithm presented here places each item into categories and operates by dealing with these categories. This allows the algorithm to remain efficient whilst still dealing with a large scale content library as the amount of categories would be expected to be in the order of tens for even a very large content library.

Items can be categorized into groups with similar durations, bandwidth requirements, and revenue potential or a subset of these characteristics. Two content items that have a similar duration and peak throughput might be placed into different categories due to one being a newer release and therefore having a higher earning potential.

Similarly, two items might be categorized differently despite have the same revenue potential if the durations are different enough to vary the cost involved in serving each content item.

The same notation and assumptions that are used in Section 3.2.1 are used here and are extended as follows. Let $r(i)$ denote the revenue generated by an accepted request for item type i . Let T_i denote the duration in seconds of flows associated with the streaming of item type i .

Every time a request for item type i^* arrives, the admission control algorithm estimates, given its knowledge of the duration and time of acceptance of currently accepted flows for the J content servers, the time interval for which the current level of bandwidth will be used by accepted flows, across all content servers (and not including that of the new request) will be maintained; this time interval is denoted $(t, t+t')$. Note that the algorithm assumes that no flows are prematurely terminated for any reason.

Every time a request for an item type arrives the algorithm iteratively computes a provisional allocation of the currently unallocated bandwidth to item types for interval $(t, t+t')$ in a manner that seeks to maximize the revenue generated for the service provider. Provisional allocations are based on the revenue values for each item type, the probability of the arrival of requests for those item types in the interval $(t, t+t')$, the peak bandwidth required for each item type, and the most recent estimates of available bandwidth from content servers to the destination. The use of the peak bandwidth is feasible as statistical multiplexing of existing flows is catered for by using current Available Bandwidth estimations. A Poisson process is assumed for the arrival of requests for item types, hence the number of arrivals for item type i in the interval $(t-t', t)$, denoted $q_i(t-t', t)$, can be taken as an estimate of the number of arrivals for the interval $(t, t+t')$. This assumption is feasible as for a large population of independent sources (end users), regardless of the individual arrival processes, the composite will tend towards Poisson arrivals. As the iterations progress the number of requests for item type i for which bandwidth has been provisionally allocated, denoted $n_i(t, t+t')$, is stored.

At each iteration the provisional allocation of bandwidth to an item type i is the one that maximizes the marginal utility to marginal cost in comparison to the other possible allocations. The marginal utility, denoted $u_i(t, t+t')$, is defined as the revenue associated with accepting a request for that item type, times the probability of an

arrival of an additional request for the item type during the interval. If the admission control request is for item type i^* then the probability of the arrival of at least one request for item type i^* in the interval is set to 1 (since this request has just arrived). The marginal utility can therefore be expressed as:

$$u_i(t, t + t')|_{i \neq i^*} = r(i) \sum_{w=n_i(t, t+t')+1}^{\infty} \frac{q_i(t - t', t)^w}{w!} e^{-q_i(t-t', t)}$$

$$u_{i^*}(t, t + t')|_{n_{i^*}(t, t+t')=0} = r(i^*)$$

$$u_{i^*}(t, t + t')|_{n_{i^*}(t, t+t') \neq 0} =$$

$$r(i^*) \sum_{w=n_{i^*}(t, t+t')+1}^{\infty} \frac{q_{i^*}(t - t', t)^w}{w!} e^{-q_{i^*}(t-t', t)}$$

The marginal cost associated with provisional allocation of an item type i , denoted $v(i)$, is approximated as the maximum bandwidth consumption of item type i over its specified duration:

$$v(i) = p(i)T_i$$

The marginal utility per marginal cost of provisionally allocating bandwidth for a request for item type i during $(t, t + t')$, denoted $\delta_i(t, t + t')$, is then:

$$\delta_i(t, t + t) = u_i(t, t + t')/v(i)$$

At each iteration the algorithm selects a provisional allocation to an item type i' , decreasing the currently available bandwidth for the interval, denoted $B(t, t + t')$, by $p(i')$. The algorithm terminates when the provisional allocation is for item type $i' = i^*$, in which case the request for item type i^* is accepted, or when the value of $B(t, t + t')$ is too small to make a given provisional allocation, in which case the request for item type i^* is rejected. The algorithm is formally specified in Algorithm 6.

Algorithm 6 Revenue maximizing selection / admission control algorithm

Input: $i^*, \{\hat{B}_{jd}(t)\}$

▷ Step 1: Initialization

- 1: Calculate $t + t'$ as the time at which the first termination of the currently accepted flows is expected to occur

 - 2: **for all** item types $i = 1 \dots I$ **do**
 - 3: Set $q_i(t - t', t)$ to the number of requests for item type i in the interval $(t - t', t)$
 - 4: Set provisional allocation $n_i(t, t + t') = 0$
 - 5: Set $\pi_i(t, t + t') = e^{-q_i(t - t', t)}$
 - 6: Set $\Pi_i(t, t + t') = 1 - \pi_i(t, t + t')$
 - 7: **if** $i = i^*$ **then**
 - 8: Set marginal utility $u_i(t, t + t') = r(i)$
 - 9: **else**
 - 10: Set marginal utility $u_i(t, t + t') = r(i)\Pi_i(t, t + t')$
 - 11: **end if**
 - 12: Set marginal cost $v(i) = p(i)T_i$
 - 13: **end for**

 - ▷ Step 2: Identify Optimal Provisional Allocation

 - 14: **for all** item types $i = 1 \dots I$ **do**
 - 15: List all candidates that maximize $\delta_i(t, t + t')$
 - 16: **end for**
 - 17: **if** list contains item type $i' = i^*$ **then**
 - 18: **for all** content servers $j = 1 \dots J$ **do**
 - 19: List all content servers $\{j'\}$ for which $\hat{B}_{jd}(t) > p(i^*)$
 - 20: **if** $\{j'\} \neq NULL$ **then**
 - 21: Select $j^* \in \{j'\} : \hat{B}_{j^*d} = \max\{\hat{B}_{j'd}(t)\}$
 - 22: **return** ACCEPT, j^*
 - 23: **else**
 - 24: **return** REJECT
 - 25: **end if**
 - 26: **end for**
-

Algorithm 6 Revenue maximizing selection / admission control algorithm (continued)

27: **else** ▷ Step 2: continued
28: Randomly select item type i'' from list of candidates that maximize $\delta_i(t, t + t')$
29: **for all** content servers $j = 1 \dots J$ **do**
30: List all content servers $\{j'\}$ for which $\hat{B}_{j'd}(t) > p(i'')$
31: **end for**
32: **if** $\{j'\} \neq NULL$ **then**
33: Select $j'' \in \{j'\} : \hat{B}_{j''*d} = \max\{\hat{B}_{j'd}(t)\}$
34: **else**
35: **return** REJECT
36: **end if**
37: **end if** ▷ Step 3: Perform Provisional Allocation

38: Set $n_{i''}(t, t + t') = n_{i''}(t, t + t') + 1$
39: Set $\hat{B}_{j''d} = \hat{B}_{j''d} - p(i'')$

▷ Step 4: Update Internal Variables

40: Set $\pi_{i''}(t, t + t') = \pi_{i''}(t, t + t') \frac{q_{i''}(t - t', t)}{n_{i''}(t, t + t')}$
41: Set $\Pi_{i''}(t, t + t') = \Pi_{i''}(t, t + t') - \pi_{i''}(t, t + t')$
42: Set $u_{i''}(t, t + t') = r(i'')\Pi_{i''}(t, t + t')$

▷ Step 5: Loop Statement

43: GOTO Step 2

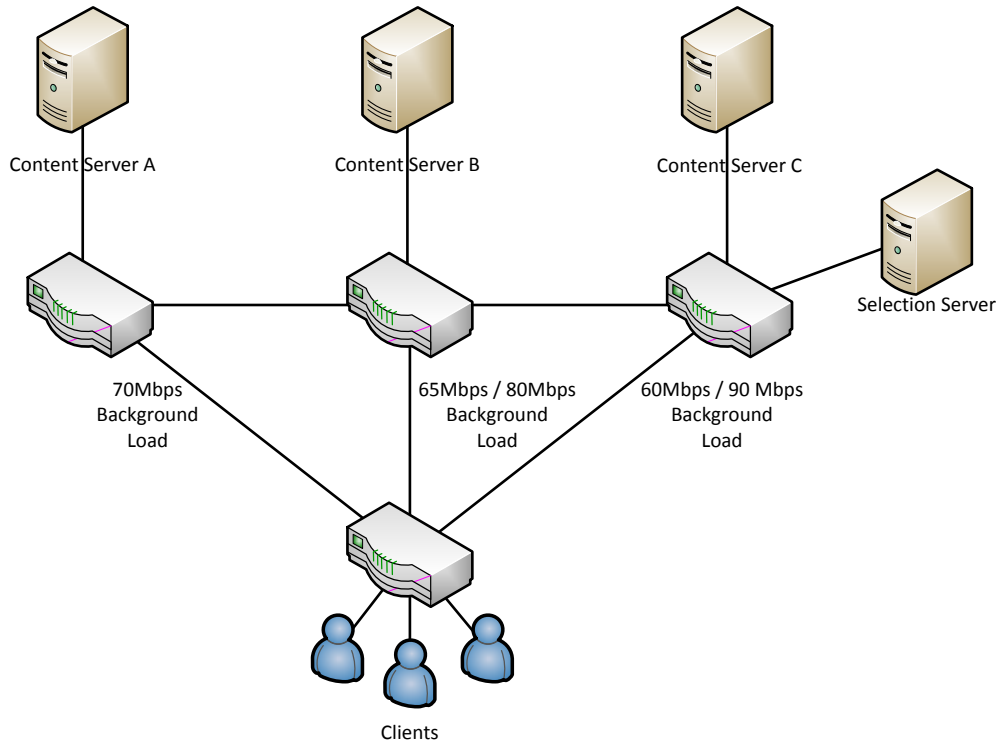

Figure 4.9: Experimental Topology Used In REVMAX evaluation.

4.2.2 Experimental Setup

The simulations were performed using the OPNET Modeler™ [OPNET Modeler \(2013\)](#) simulation environment. The framework is deployed in a scenario where there is three different content servers (A,B,C). The traffic traces used are taken from actual videos using various CODECs by [Seeling et al. \(2004\)](#) and use [Cheng et al. \(2007\)](#) to inform the distribution of mean durations, enabling us to create realistic traffic flows. For the purposes of control and analysis, these experiments concentrate on requests arriving into the network from a single access point and the intermediate topology between the content servers and the access point is specified to contain Fast Ethernet (100 Mbps) links. The content items are categorised into three groups and assigned different priorities and characteristics as shown in Table 4.6. Each category of content generates an average of 60 requests per hour as the inter repetition time for requests is exponentially distributed with an average of 60 seconds.

The number of links between the content servers and the clients access point was kept equal at 2 hops and background loads were added to the paths by using OPNETs

Table 4.6: Content Priorities and Characteristics.

Priority	Average Length	Cost
High	20mins	\$9
Middle	20mins	\$3
Low	10mins	\$1

traffic generators. These traffic generators provided a base background traffic of 70 Mbps, 65 Mbps, and 60 Mbps on the paths of the three content servers mentioned, as shown in Figure 4.9. The packet sizes for the background loads were uniformly distributed with an average of 576 bytes (IPv4 MTU).

Three algorithms were examined using the simulated environment of the selection / admission control framework. Two of these approaches have already been presented in Algorithm 1 and 6 and are referred to from here as ABAC and REVMAX respectively. The third approach to be included in the comparison is as follows. Each path is seen to have a static amount of available bandwidth, and this is reduced by the peak rate of each accepted flow that is currently active on that path (referred to as STATIC).

4.2.3 Experimental Results and Analysis

The algorithms discussed previously are compared when operating in both a steady state network environment with the background traffic as specified previously and also in the situation where there is a degradation in the condition of the network, such as could be caused by an increase in background traffic for example. To create the increase in background traffic a step change is introduced to two of the traffic generators. The 65Mb background load is increased to 80Mb and the 60Mb background load is increased to 90Mb. This is also shown in Figure 4.9. Overall, this reduces the available bandwidth from 105Mb down to 60Mb with a significant change in where the majority of that bandwidth is available.

Firstly, the end to end delays experienced in the network is examined. It can be seen from Figure 4.10 that the algorithms are all performing to a satisfactory level when the network is in a steady state. STATIC even shows lower delay but this is due to its under utilisation of the available resources, as a result of statistical multiplexing. The benefit of the two algorithms presented in this thesis can be seen in Figure 4.11. All 3

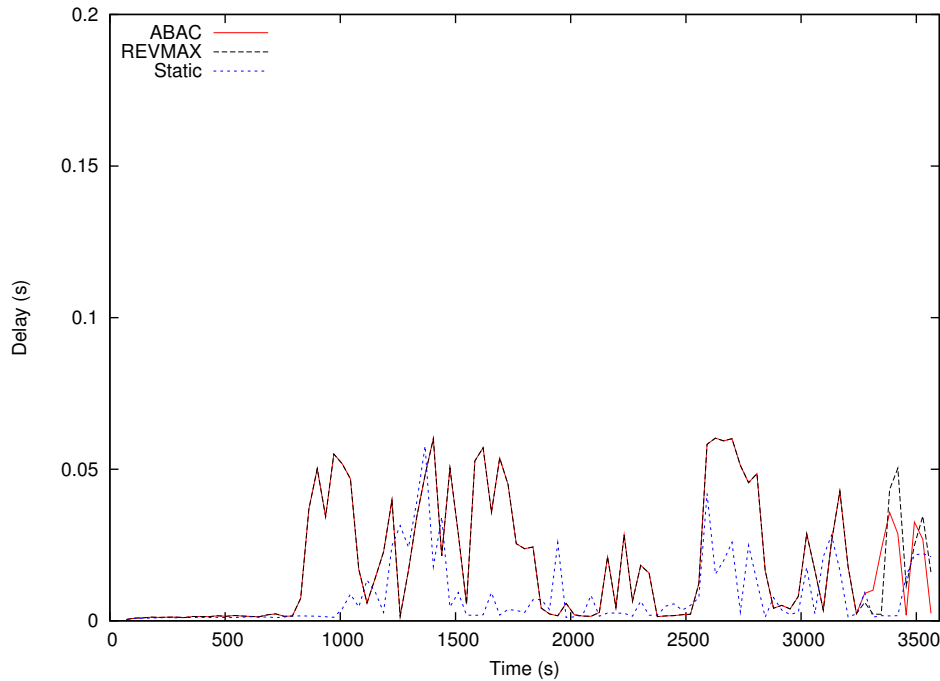

Figure 4.10: End to End Delays for the Steady State Network.

of the algorithms experience end to end delays that are less than the 200 ms specified as the acceptable limit by (Rahrer *et al.*, 2006, p.53-55). However, both the ABAC and REVMAX are able to adapt to the change in network and the delay is lessened whereas the STATIC approach suffers a higher delay until the increased background traffic is no longer present, as it is obviously unaware of the deteriorated network conditions.

An extension of this shortcoming is that if more bandwidth were to become available (due to a decrease in background traffic) the STATIC approach would further under utilise the resources that were present. Another disadvantage to the STATIC approach is that assigning adequately accurate available bandwidth estimates for each of the network paths is quite a difficult task, given our scenario of an unknown and uncontrolled intermediate topology. For these reasons, the STATIC approach is discarded and only the ABAC and REVMAX algorithms are compared for the remainder of this chapter.

The ABAC and REVMAX algorithms can both be seen to adapt to the worsening network conditions in the increased background traffic scenario. This is due to the fact that the admission control component of the framework rejects more flows when there is increased background traffic. Figures 4.12 and 4.13 compares the requests admitted

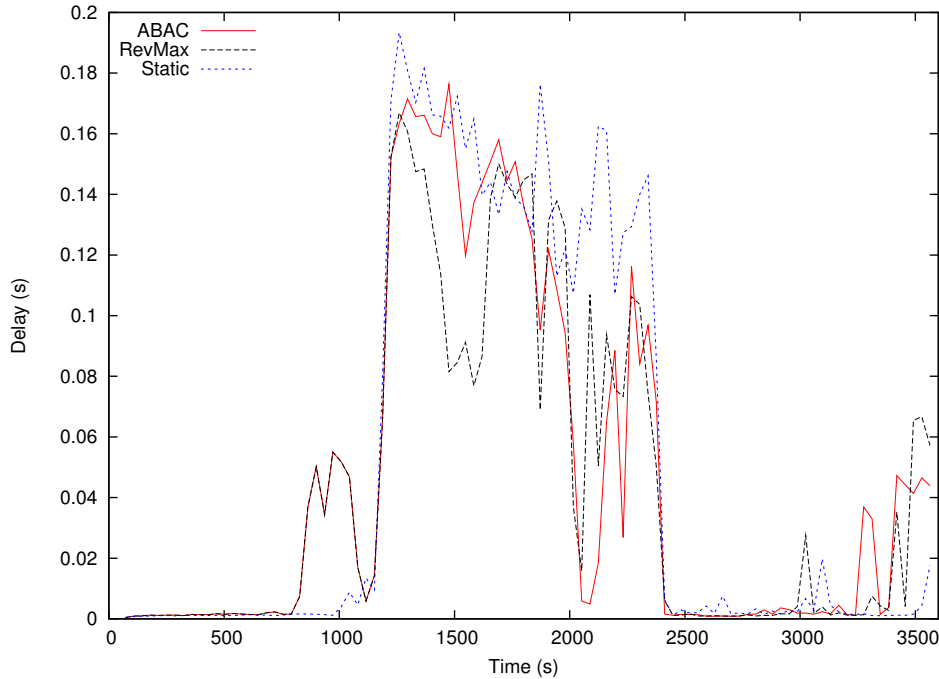

Figure 4.11: End to End Delays for the Increased Background Network.

during the steady state and increased background scenarios for each of the algorithms. It can be seen that for the same scenario, both the ABAC and REVMAX algorithms admit a similar number of flows overall, thus explaining the resultant similar delays experienced in the network. Their ability to adapt to the increase in background traffic is demonstrated by the decrease in overall requests accepted by each algorithm. ABAC and REVMAX accept 5.5% and 6.5% less requests, respectively.

The advantage of REVMAX over ABAC is readily apparent when the admitted flows are examined in terms of the revenue they provide to the IPTV operator. This information is summarized in Table 4.7. Comparing the revenue generated by both algorithms in the steady state network, a relatively modest improvement can be seen when using REVMAX (3%). This is due to the fact that in steady state REVMAX can accommodate the majority of requests from all priorities, and therefore operates in a similar fashion to ABAC.

As has been mentioned, fewer requests are accepted overall in the Increased Background traffic scenarios. The ability of the REVMAX approach to prioritize requests of a higher revenue means that it returns a noticeably greater revenue than ABAC in

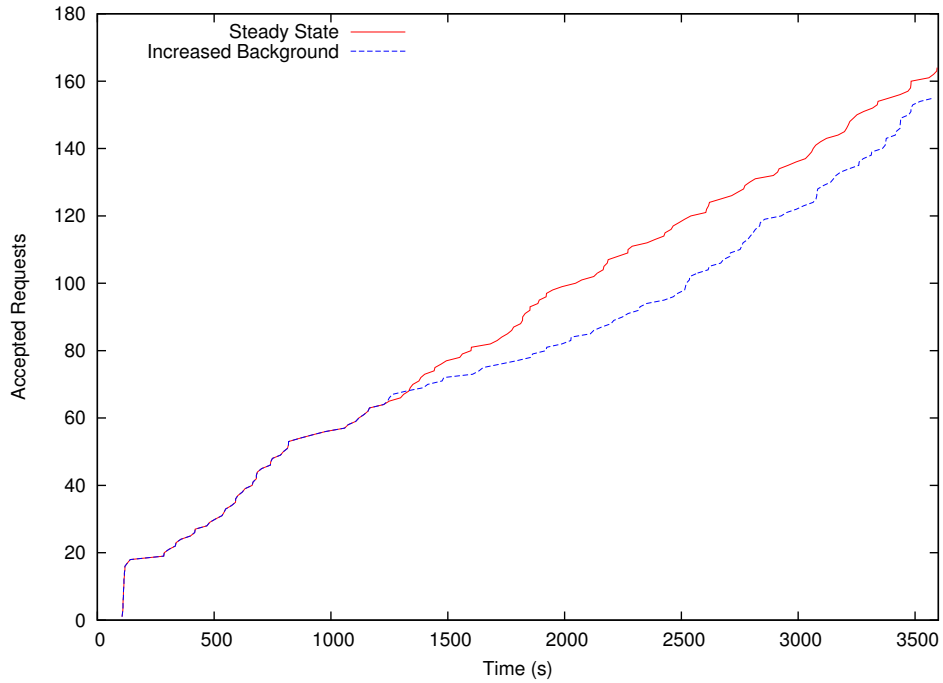

Figure 4.12: Requests admitted by ABAC.

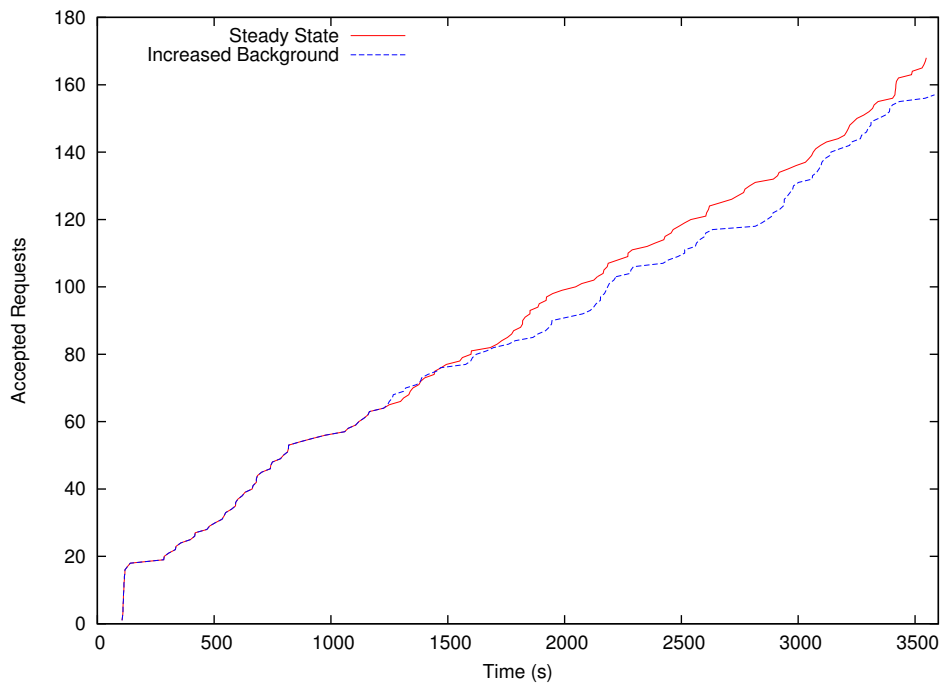

Figure 4.13: Requests admitted by REVMAX.

Table 4.7: Summary of Revenue Generated.

	Steady State	Increased Background
<i>ABAC</i>	\$712	\$633
<i>REVMAX</i>	\$734	\$709

these poorer network conditions (12% greater).

This is the strength of the REVMAX algorithm and is further apparent when one looks at how each of the algorithms adapts to the change in network conditions. ABAC shows a significant loss of revenue (-11%) due to requests being rejected based solely on the current available bandwidth estimates. By being aware of the probability that a higher value request will arrive, REVMAX is capable of preserving and continuing to accept higher value requests and thus limit the loss in revenue (-3%) despite degraded network conditions.

Figures 4.14 and 4.15 are stacked graphs of the two algorithms exhibiting this behaviour. In Figure 4.14 all the content priorities see a reduction in the throughput they are generating. This can be compared to Figure 4.15 where the higher the priority, the lower the reduction in throughput for that particular priority.

Figures 4.16 and 4.17 serve to highlight this adaptation to the new available bandwidth. In Figure 4.16, from 1200 seconds onwards, it can be seen that the ABAC throughput of the top priority content starts to fade away as much less new requests are admitted by the framework. However, REVMAX continues to use the few requests it can admit to prioritize the most beneficial requests from a revenue perspective. Figure 4.17 shows that whilst both algorithms show a lowered throughput for low priority traffic when the background is increased, REVMAX shows a greater decrease as it is rejecting a higher percentage of low priority traffic.

To demonstrate the prioritisation of REVMAX of the top priority requests, Figure 4.18 is presented. This is the cumulative total of top priority flows. In this figure a split is apparent at 1200 seconds with REVMAX continuing to accept the requests for top priority item types. This is in contrast to ABAC which levels out for the duration of the increased background and then begin to increase again as more requests are accepted when the bandwidth becomes available again.

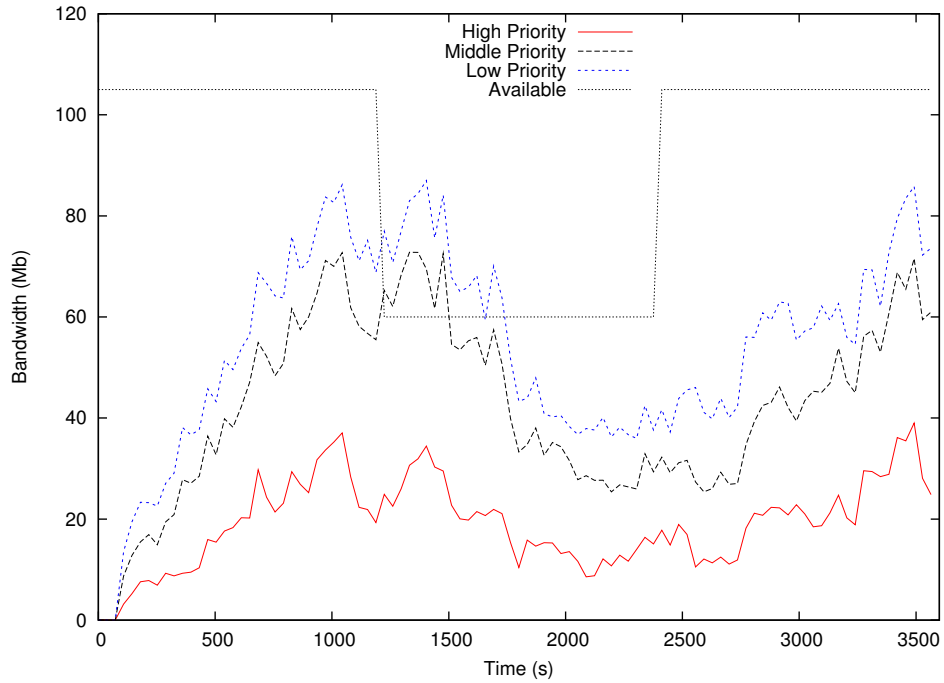

Figure 4.14: ABAC Utilization.

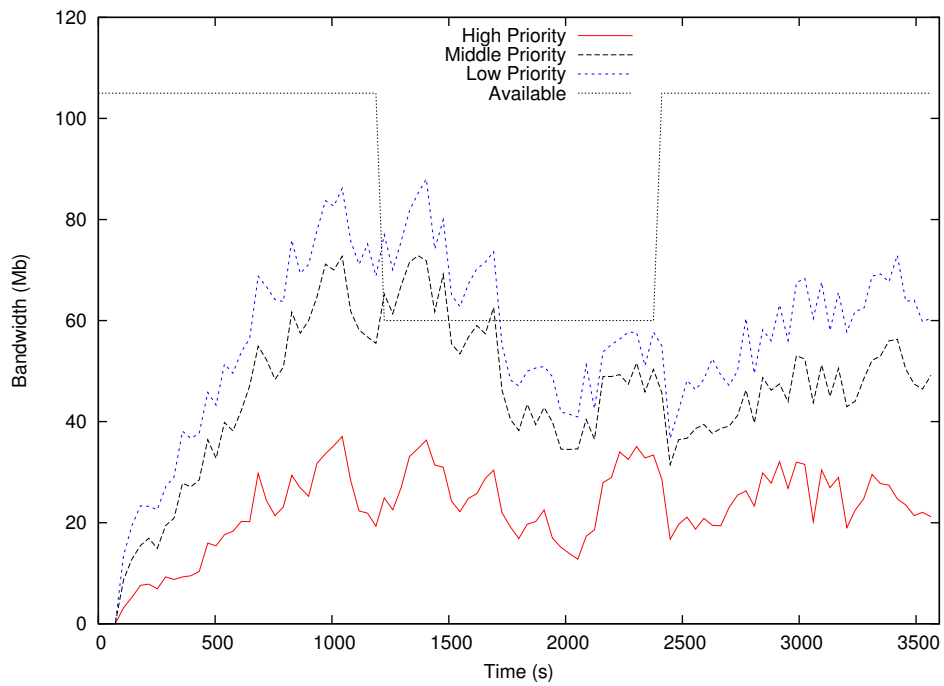

Figure 4.15: REVMAX Utilization.

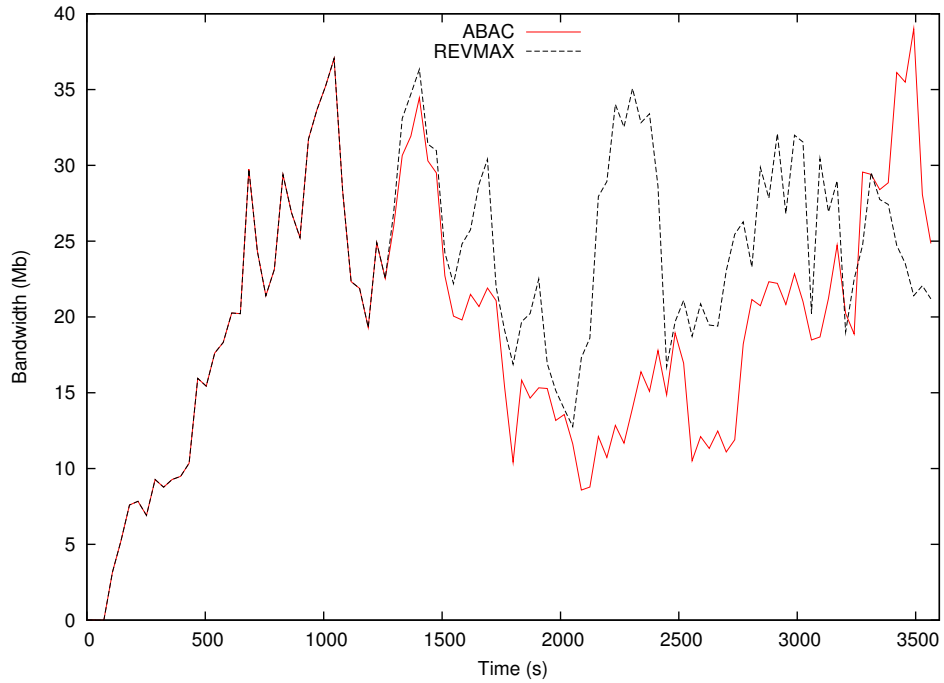

Figure 4.16: Comparison of Top Priority Utilizations.

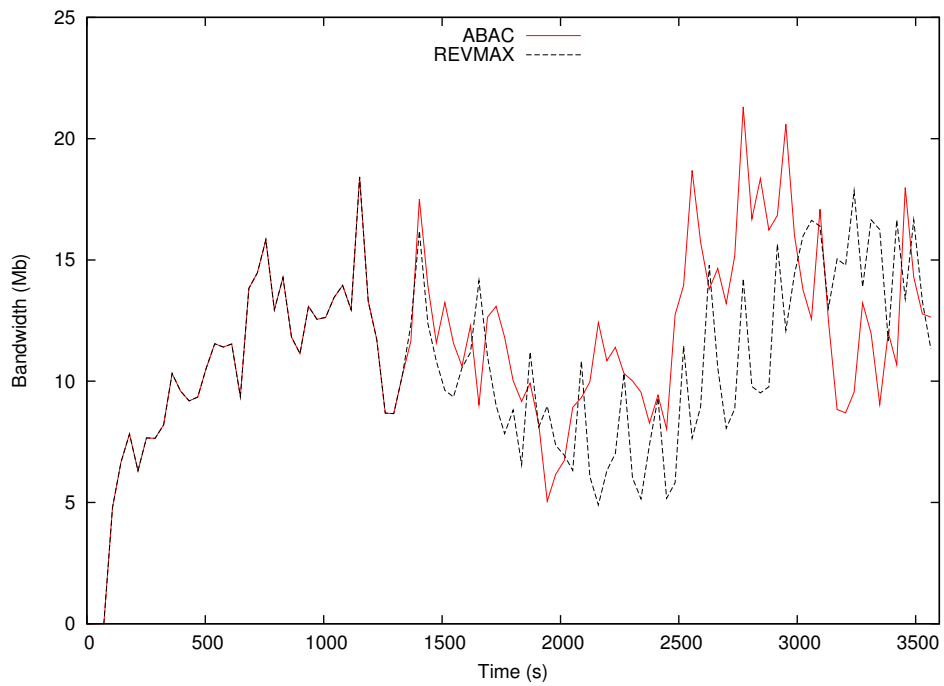

Figure 4.17: Comparison of Low Priority Utilizations.

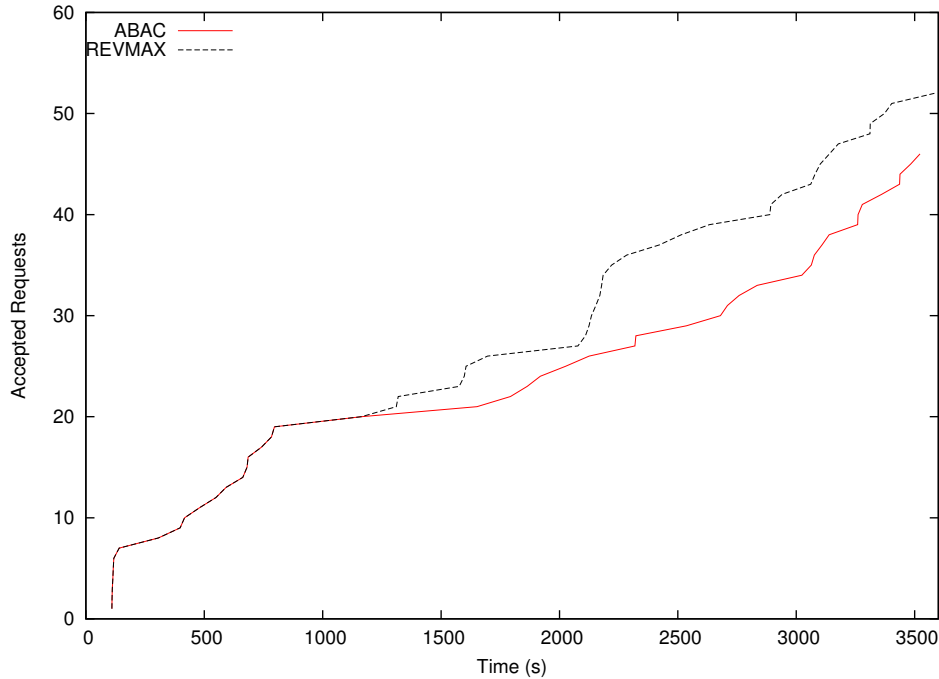

Figure 4.18: Cumulative Total of Top Priority Requests Admitted.

4.3 Summary

The aim of research question two was to investigate what benefits Available Bandwidth estimation could provide at an intra service provider level. This chapter has clearly shown the benefits that can be gained from both a resources utilization and a revenue generation perspective.

Firstly, this chapter presented an algorithm for adaptive content replication that targeted the content requiring replication and coupled this with Available Bandwidth estimates to bring online the servers that could be used most beneficially. The combination of replicating the content most in need and using the locations that can provide the best contribution to the system enabled a very efficient and rewarding use of resources by a service provider.

Following this, this chapter presented an investigation into the selective acceptance of requests with the goal of maximising generated revenue. The combination of three factors: the profit gained by accepting a request, the probability of higher value requests being present, and the resources available to the service provider served as the basis for

developing an algorithm that built on the work presented in Chapter 3. This algorithm was shown to use the finite resources available to a service provider in a manner that maximised the revenue a service provider could generate.

The algorithms presented in this chapter were developed in isolation as discrete algorithms but it would be an interesting area of further research to investigate the combining of these algorithms. The research would need to develop a knowledge for when it is better to bring more servers online via the content replication algorithm compared to maintaining the existing servers and rejecting requests using the revenue maximising algorithm.

The main contributions of this chapter are therefore in the form of two algorithms and their associated benefits to the service provider: the adaptive content replication algorithm and the revenue maximising admission control algorithm.

Chapter 5

Use of ABETs in External Business Partner Interactions

The focus of this chapter is on addressing the third and final research question. A scenario is examined where an IPTV service provider has content distributed across multiple third party data centres and is interested in maximising green energy usage. This example scenario was chosen as it is of ever increasing concern for a business to maximise their ratio of Green Energy to Brown Energy usage. This concern can have its roots in a moral obligation, or equally likely in a financial incentive to make use of Green Energy as the cost of utilising Brown Energy increases.

After first presenting the model for calculation of the Green Energy Metric at a particular data centre, this chapter progresses with the presentation of a baseline algorithm for comparisons of Green Energy usage. This is followed in turn by two approaches which show it is possible to improve Green Energy usage while controlling Quality of Service violations within an IPTV system.

The first of these approaches is reactive in nature and intended for use in unpredictable and varying network and energy conditions as it conducts an inline analysis of the resources in the system and uses this to perform both admission control and server selection.

The second algorithm is designed to be run offline and its strengths are suited to use in a steady state network condition where resource provisioning and planning can take place more effectively. This algorithm is a micro genetic algorithm that attempts to optimally place the requests predicted for the upcoming time period.

Having presented these algorithms, an investigation into their efficacy and the resultant benefits to an IPTV Service Provider of utilising Available Bandwidth estimation in conjunction with Green Energy information provided from these external data centres is discussed. These benefits are examined with a focus upon the stated goals of governing both the Quality of Service experienced and the Green Energy exploited.

The research presented in this chapter has been submitted for publication in [Meskill *et al.* \(2015\)](#).

5.1 The Green Index Metric

The formulation of the Green Index (GI) metric is now outlined. This is used to model the availability of green energy in the data centres housing the Content Servers. Figure 5.1 provides an overview of how an IPTV service provider can use geo-distributed data centres to store and deliver IPTV content. These data centres are assumed to be located in different geographical regions, where the weather patterns are assumed to vary. It is assumed that each data centre has access to a mix of energy sources, specifically renewable energy from local wind turbines and/or photovoltaic solar panels, as well as non-renewable (“brown”) energy provided from the electricity grid. For simplicity, it is assumed that all energy supplied from the grid is brown energy (generated by fossil fuels).

The Green Index (GI) of a Content Server j , denoted GI_j is defined to be a time-varying function of the rates of generation of renewable energy in the Contents Servers data centre, denoted $E_j^R(t)$, to the rate of total energy consumption in the same data centre, denoted $E_j(t)$. That is:

$$GI_j(t) = \frac{E_j^R(t)}{E_j(t)} \quad (5.1)$$

where $E_j^R(t)$ is the combined rate of energy generation by wind turbines, denoted $E_j^{wt}(t)$, and by photovoltaic panels, denoted $E_j^{sol}(t)$. That is:

$$E_j^R(t) = E_j^{wt}(t) + E_j^{sol}(t) \quad (5.2)$$

In the (typical) case where the local renewable energy sources are not generating sufficient power to fulfil the requirements of the data centre energy must be drawn down

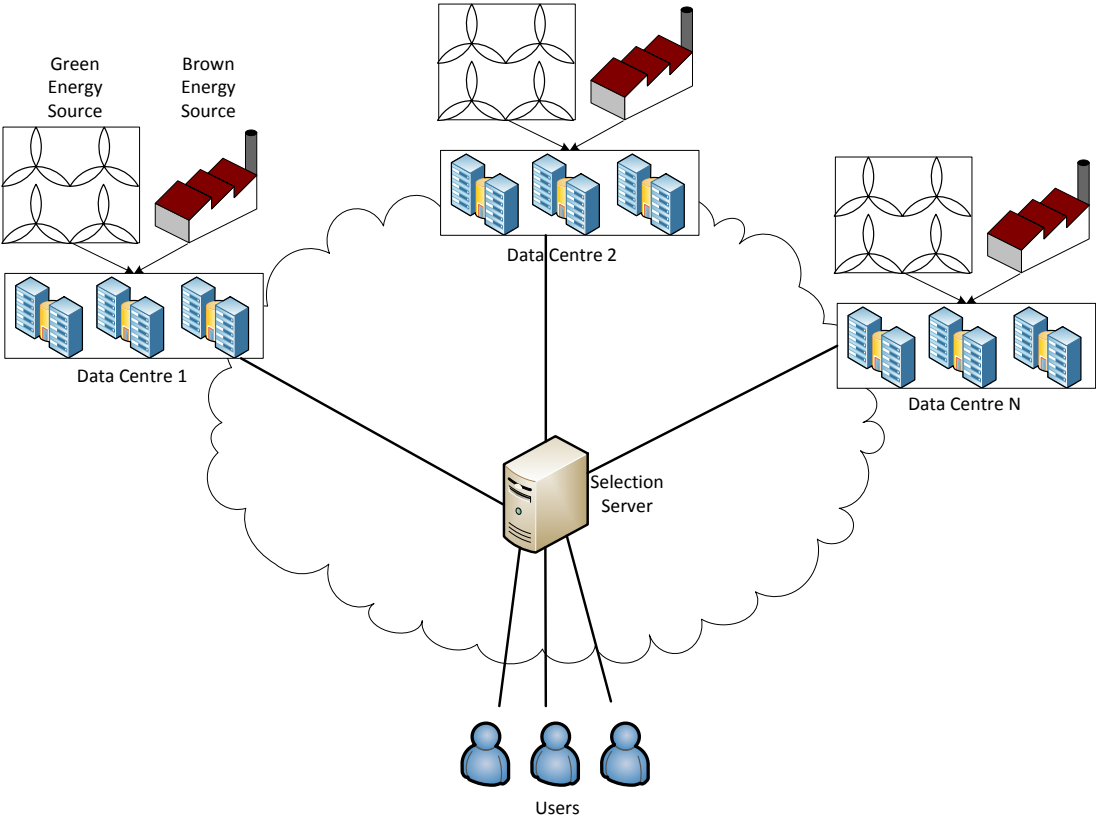

Figure 5.1: Data-Centre Architecture. Each Data-Centre has varying amounts of “green” and “brown” energy sources.

from the grid. Given the stated assumption that power from the grid is exclusively from non-renewable sources, the required brown energy over time for Content Server j , denoted $E_j^B(t)$, can be expressed as:

$$E_j^B(t) = \begin{cases} E_j(t) - E_j^R(t) & GI_j(t) < 1 \\ 0 & \text{otherwise} \end{cases} \quad (5.3)$$

To calculate the rates of wind and solar energy generation over time, as used in Equation 5.2, the following equation is used:

$$E_j^{wt}(t) = \sum_{k=0}^{K_j^{wt}} E_{jk}^{wt}(t) \quad (5.4)$$

$$E_j^{sol}(t) = \sum_{k=0}^{K_j^{sol}} E_{jk}^{sol}(t) \quad (5.5)$$

where K_j^{wt} and K_j^{sol} respectively denote the number of wind turbines and photovoltaic panels at that data centre housing Content Server j , and where $E_{jk}^{wt}(t)$ and $E_{jk}^{sol}(t)$ respectively denote the time varying rate of energy generation of wind turbine / photovoltaic panel k at the data centre housing Content Server j . The latter are themselves functions of prevailing wind speed (denoted $ws_j(t)$) and solar irradiance, denoted $si_j(t)$. That is:

$$E_{jk}^{wt}(t) = f(ws_j(t)) \quad (5.6)$$

$$E_{jk}^{sol}(t) = f(si_j(t)) \quad (5.7)$$

For the purpose of developing the algorithm, the data centre GI was based upon it's overall energy usage. The algorithm could be extended in future to consider how efficiently each data centre uses green energy. One potential method for modelling this extension could be via a scaling ratio that favours efficient usage *within* the data centre. That would enable more efficient green energy usage in the overall system.

5.2 Green Index Aware Algorithms

As mentioned previously, the concerns of this IPTV admission control framework are now twofold. The first of these concerns is to enable an efficient use of any green energy that is present in the data centres. However, this requirement must be addressed in conjunction with the second concern. That is to ensure the adequate delivery of content from the content servers present in the Data Centres to the clients while ensuring Quality of Service commitments are maintained.

To achieve these dual goals the admission control framework first introduced in Section 3.2.1 is expanded to incorporate GI information being reported from externally operated data centres. This is demonstrated in Figure 5.2, where Green Index updates are calculated periodically at the content server and sent to the selection server. These Green Index are calculated using current Wind and Solar energy values. In a manner similar to that described in Section 3.2.1, the selection server uses this reported Green Index value to perform Server Selection and/or Admission Control.

The following subsections presents these Green Index aware algorithms that have been incorporated into the Admission Control Framework. The first presented algorithm is used as a baseline comparison which provides information of the Green Energy benefits that can be gained when maximising Green Energy usage is the only objective.

Following this, two algorithms are presented which attempt to achieve the dual concerns mentioned. The first of these is a reactive inline algorithm while the second is based on a micro Genetic Algorithm and attempts to predict the upcoming requests and plan accordingly.

5.2.1 Green Index Based Server Selection Algorithm

The Green Index based Admission Control (GIAC) is focused solely on how to distribute incoming requests with respect to the current energy conditions being reported from each server.

It bases its decision on which of the content servers has the highest Green Index at the time of the request arrival. The calculation of the Green Index is as presented in Section 5.1 and the algorithm is presented in Algorithm 7. The notation used in this algorithm is consistent with that used in Table 3.9 and extra notation used is tabulated in Table 5.1.

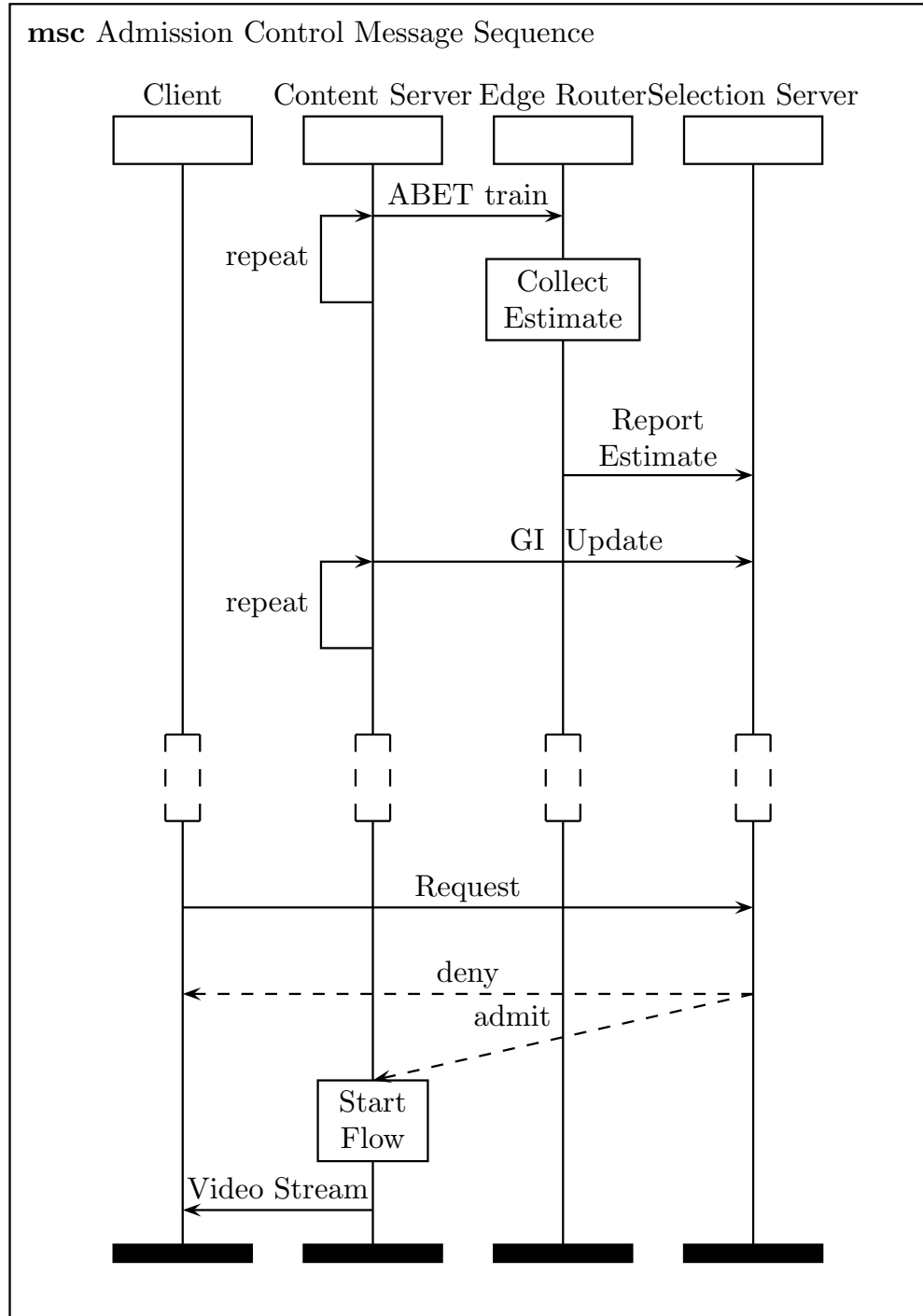

Figure 5.2: Extended Architecture Component Interaction.

Algorithm 7 Green Index based server selection algorithm

- 1: Select $j^* \in \{j'\} : \hat{G}_{j^*} = \max\{\hat{G}_j\}$
 - 2: Return {ACCEPT, j^* }
-

5.2.2 Available Bandwidth & Green Energy Aware Server Selection / Admission Control Algorithm

It can be seen that both the approaches mentioned so far are effective in achieving a single objective (minimising Quality of Service violations or maximising Green Energy usage) but to be feasible for use in a green energy aware IPTV scenario, any algorithm or approach should be able to incorporate both of these objectives.

Such an algorithm is Available Bandwidth and Green Index based Admission Control (ABGIAC) and this is formally presented in Algorithm 8. ABGIAC uses Available Bandwidth estimates in conjunction with information about the Green Index of the data centre as input to its decision making process. This combination of the two inputs allows the algorithm to maintain its Quality of Service priorities while improving the green efficiency of the IPTV network.

The algorithm operates as follows. Assume there are I individual content items made available by the service provider. Let $i = 1, \dots, I$ denote an arbitrary type of content item. Let r denote a particular bitrate from R , the set of supported bitrates. Assume that the service provider maintains J content servers, each with a single dedicated egress link to the core network. Let $j = 1, \dots, J$ denote an arbitrary content server. Let \hat{B}_{jd} denote the estimate of available bandwidth between content server j and edge router d .

Let G_j be the current Green Index of content server j as reported to the selection server. A subset of content servers $\{j'\}$ is populated such that every element in the subset has the bandwidth to serve at least the lowest supported bitrate. For every content server in this subset, the weighting of it being the selected server is calculated as

$$W(j) = W(AB_{jd}) * W(GI_j) \tag{5.8}$$

where $W(AB_j)$ is the ratio of Available Bandwidth at j to the total Available Bandwidth from all servers to the edge router (d) in question and can be further expressed as

$$W(AB_{jd}) = AB_{jd} / \sum_{k=0}^J AB_{kd} \quad (5.9)$$

and $W(GI_j)$ is the ratio of the Green Index at j to the total Green Index. If the situation occurs that there is no Green Energy for a particular content server (during a night with no wind for example), the Green Index of that content server is explicitly set to 0.01. The purpose of this is to make the content server significantly less favourable due to its reliance on brown energy but to still include it in the calculations as its bandwidth resources may be significant and required by the IPTV provider.

$$W(GI_j) = \begin{cases} 0.01 & GI_j = 0 \\ GI_j / \sum_{k=0}^J GI_k & \text{otherwise} \end{cases} \quad (5.10)$$

A randomly selected number uniformly distributed between zero and W_{total} is generated to determine which content server is selected where W_{total} represents the cumulative total of each $W(j)$.

$$W_{total} = \sum_{j=0}^J W(j) \quad (5.11)$$

Table 5.1: Notation for GIAC, ABGIAC and GA Admission Control Algorithms.

Notation	Description
I	The number of individual content items offered by the service provider.
i	A content item.
i^*	A particular requested content item.
r_{i^*}	The bitrate required by i^* .
J	The number of content servers, each of which hosts all content items.
j	One of the J content servers.
d	The destination node that is the source of the request for item type i .

Continued on next page

Table 5.1 – continued from previous page

Notation	Description
\hat{B}_{jd}	The current available bandwidth estimate between content server j and destination d .
i^*	The item to which the admission request relates.
j^*	The selected content server.
$\{j'\}$	The set of potential content servers.
$W(j)$	The weighting of a particular content server j .
\hat{G}_j	The current Green Index for content server j .
W_{total}	The sum of all the content server weightings.
$\{EXT\}$	The external memory set of GA solutions.
$\{MP\}$	The master population of GA solutions.
$\{MP_{rep}\}$	The subset of $\{MP\}$ containing replaceable GA solutions.
$\{MP_{non}\}$	The subset of $\{MP\}$ containing non-replaceable GA solutions.
$\{IP\}$	The subset of $\{MP\}$ containing a particular iteration population.
$\{IP_{new}\}$	The set containing newly generated GA solutions.
ip	A particular solution from $\{IP\}$.
ip_{cr}	A crossover of two ip elements.
ext	A particular solution from $\{EXT\}$.

5.2.3 GA-Based Request Allocation

This section presents the Genetic Algorithm (GA) optimisation approach for allocating the end-user content requests to servers in specific data-centres. There are two component parts to this approach: the optimisation process itself which occurs offline and the server selection component which occurs online as a reaction to the receipt of a request. Both of these components are presented in turn below.

5.2.3.1 Micro Genetic Algorithm

The purpose of an optimisation algorithm is to help to better determine the most suitable volume of requests to be allocated to each server, given potentially conflicting goals of maximising the greenness of the system while maintaining a sufficient level of available bandwidth. Using optimisation can lead to better results as it considers a more complete knowledge of the system through allocation of groups of requests, rather than piece-meal request allocation. This allows the placement algorithm to have a better understanding of the impact of the allocation decisions.

Algorithm 8 ABGIAC based server selection / admission control algorithm

Input: i^*

- 1: List all content servers $\{j'\}$ for which $\hat{B}_{jd} > r_{i^*}$
 - ▷ Set Server Selection Weightings
 - 2: **if** $\{j'\} \neq NULL$ **then**
 - 3: **for all** $j \in \{j'\}$ **do**
 - 4: Set $W(j) = (\hat{G}_j / \sum_{k=0}^J \hat{G}_k) * (\hat{B}_{jd} / \sum_{k=0}^J \hat{B}_{kd})$
 - 5: **end for**
 - ▷ Select a server using these weightings
 - 6: Set $W_{total} = \sum_{j=0}^J W(j)$
 - 7: Randomly Select $rand$ in the range $0 \dots W_{total}$
 - 8: **for all** $j \in \{j'\}$ **do**
 - 9: **if** $(rand > W(j)) \ \& \ (rand \leq W(j + 1))$ **then**
 - 10: $j^* = j$
 - 11: **end if**
 - 12: **end for**
 - 13: Return $\{ACCEPT, j^*\}$
 - 14: **else**
 - 15: Return $\{REJECT\}$
 - 16: **end if**
-

For the optimisation process being undertaken here, a specific form of genetic algorithm is used, the micro Genetic Algorithm [Krishnakumar \(1990\)](#). Micro GAs are designed to improve the execution time of genetic algorithms by being more lightweight. Given this improved execution time, and the ever-increasing capabilities of cloud services to process enormous amounts of work in a short amount of time, the micro GA is more suitable for use in an IPTV admission control / server selection environment where it is intended to execute the micro GA offline on an hourly basis.

Before discussing the micro GA in detail, it is necessary to present how the fitness of a potential solution (i.e. request distribution) is determined. Firstly the individual fitness of a data centre is a combination of the Available Bandwidth \hat{B}_j remaining at the data centre when it has served its allocated requests and the data centres Green Energy GI_j used to cover the workload of each individual request R_i . This remaining Available Bandwidth is calculated as the difference between the most recent Available Bandwidth estimates and the total bandwidth required to complete the servicing of existing requests. The fitness of the overall solution can be given by summing the fitness for each data centre.

$$\max \sum_{j=1}^J \sum_{i=1}^I ((1 - \alpha)(R_i \cdot GI_j) + \alpha(\hat{B}_j)) \quad (5.12)$$

In the above expression, α is a weighting that can be given to the objectives of maximising Green Energy usage and maximising Available Bandwidth. That weighting is evenly distributed for this scenario but could be changed to prioritise one objective over the other.

The micro GA operates as follows. A master population $\{MP\}$ is created containing 1000 randomly generated valid request distributions. A request distribution is valid if the following constraints are satisfied:

- The request distribution has allocated all the requests expected for each content item.
- For each data centre, the sum of the workload for servicing each request assigned there does not exceed the data centres max workload.
- For each data centre - edge router path, the request distribution does not cause the currently reported Available Bandwidth on that path to be exceeded.

This master population is evenly split into a replaceable $\{MP_{rep}\}$ and non-replaceable $\{MP_{non}\}$ portion of the population. Having a non-replaceable portion helps to ensure diversity in the master population, thus helping to prevent the genetic algorithm converging on a local maximum. For each iteration of 1500 iterations, the following is performed. An iteration population $\{IP\}$ of size 50 is selected and is a random subset of $\{MP\}$.

Five generations of crossovers occur in each iteration. A crossover is the process of randomly taking two solutions from $\{IP\}$ and combining them to form a new valid request distribution. This crossover process is repeated until a new iteration population $\{IP_{new}\}$ has been filled. During the final four of the five generations, the fittest solution is automatically brought forward to the next generation. This is one of the mechanisms to help the micro GA converge faster than a standard Genetic Algorithm. For the next generation, the iteration population used is set to be $\{IP_{new}\}$.

The settings for population size, number of iterations and number of crossovers are heuristically chosen values. These values were settled upon after testing as values that are efficient in relation to execution time and result fitness.

As the iterations progress, a set of solutions termed the external memory $\{EXT\}$ is filled with the two fittest solutions generated in this iteration. When the max size of 200 has been reached, a check on whether the two fittest this iteration are fitter than the two least fit in $\{EXT\}$ takes place. If they are fitter, they take the place of the two least fit in $\{EXT\}$. A similar check and replacement occurs against the two least fit in $\{MP_{rep}\}$ before the next iteration commences.

On the completion of all 1500 iterations¹, the fittest request distribution in $\{EXT\}$ is selected as the request distribution to be used for the coming hour. This is presented formally in Algorithm 9.

5.2.3.2 Server Selection

The server selection component allocates requests for content items to various servers based on the plan provided by the micro GA. This is done as follows. When a request for content item i is received, a set $\{n_{i^j=1}, n_{i^j=2}, \dots, n_{i^j=J}\}$ is retrieved. This is the

¹The number of iterations was heuristically chosen based on a trade-off between the time taken to provide a solution and the improvement that can be gained in results when more iterations are executed.

Algorithm 9 Genetic Algorithm - Request Optimisation

```

1: Set  $\{EXT\} = \{\}$  ▷ Initialization

        ▷  $\{MP\}$  contains 1000 random request distributions
2: Randomly populate  $\{MP\}$  such that  $|\{MP\}| = 1000$ 

        ▷ Divide  $\{MP\}$  into replaceable and non-replaceable
3: Set  $\{MP_{rep}\} \cup \{MP_{non}\} = \{MP\}$ 
4: Set  $\{MP_{rep}\} \cap \{MP_{non}\} = \{\}$ 

5: for all 1500 iterations do ▷ Choose random subset  $\{IP\}$  of size 50
6:   Set  $\{IP\} \subset \{MP\}$  where  $|\{IP\}| = 50$ 

7:   for all 5 generations do ▷ Bring forward the fittest solution
8:     if generation > 1 then
9:       Sort  $\{IP\}$  by descending fitness
10:      Select  $ip$ , first element in  $\{IP\}$ 
11:      Add  $ip$  to  $\{IP_{new}\}$ 
12:     end if

13:     while  $|\{IP_{new}\}| < 50$  do
14:       Randomly select  $ip_1 \in \{IP\}$  and  $ip_2 \in \{IP\}$ 
15:       Set  $ip_{cr}$  to be a cross of  $ip_1$  and  $ip_2$ 
16:       Add  $ip_{cr}$  to  $\{IP_{new}\}$ 
17:     end while

18:     Set  $\{IP\} = \{IP_{new}\}$ 
19:   end for

```

Algorithm 9 Genetic Algorithm - Request Optimisation (continued)

▷ Compare 2 fittest from $\{IP\}$ to least fit in $\{EXT\}$ and $\{MP_{rep}\}$

```

20:  for 2 loops do
21:      Sort  $\{IP\}$  by descending fitness
22:      Sort  $\{EXT\}$  by ascending fitness
23:      Select  $ip$ , first element in  $\{IP\}$ 
24:      Select  $ext$ , first element in  $\{EXT\}$ 

25:      if  $|\{EXT\}| < 200$  then
26:          Add  $ip$  to  $\{EXT\}$ 
27:      else if  $\text{fitness}(ip) > \text{fitness}(ext)$  then
28:          Remove  $ext$  from  $\{EXT\}$ 
29:          Add  $ip$  to  $\{EXT\}$ 
30:      end if

31:      Sort  $\{MP_{rep}\}$  by ascending fitness
32:      Select  $mp_{rep}$ , first element in  $\{MP_{rep}\}$ 

33:      if  $\text{fitness}(ip) > \text{fitness}(mp_{rep})$  then
34:          Remove  $mp_{rep}$  from  $\{MP_{rep}\}$ 
35:          Add  $ip$  to  $\{MP_{rep}\}$ 
36:      end if
37:  end for
38: end for

39: Sort  $\{EXT\}$  by descending fitness
40: RETURN  $ext$ , first element in  $\{EXT\}$ 

```

Table 5.2: Data Centre Characteristics.

DC	# Turbines (K_t)	# Solar Panels (K_p)
California	21	14
Florida	10	10
Minnesota	12	47
New York	34	79
Texas	8	65
Washington	16	38

set of the number of requests n for i that each server j is allocated to serve in the plan for this time period. Using this set, it is possible to ensure that the requests intended to be allocated to a particular server are distributed evenly over the time period covered by the GA provided plan.

This is achieved by collating the set into a single chronological list of servers to be chosen. The ordering is determined by the number of requests per server and the duration of the time period that the plan covers. The server to allocate a request to is then chosen sequentially from this list.

5.3 Evaluation

In this section, the simulation model used to evaluate the aforementioned algorithms is presented. This is followed by the presentation and analysis of the experimental results.

5.3.1 Simulation Model

The simulation model is developed using the OPNET ModelerTM **OPNET Modeler (2013)** simulation environment. It consists of six data centres geographically distributed throughout the United States, namely California (CA), Florida (FL), Minnesota (MN), New York (NY), Texas (TX), and Washington (WA). Realistic traffic loads and a feasibly calculated number of turbines and solar panels are used in our simulations to create genuine energy profiles for each location. The characteristics of each data centre are summarised in Table 5.2.

These characteristics are used in conjunction with actual solar and wind values recorded in each of these locations to create the Green Index for each data centre as

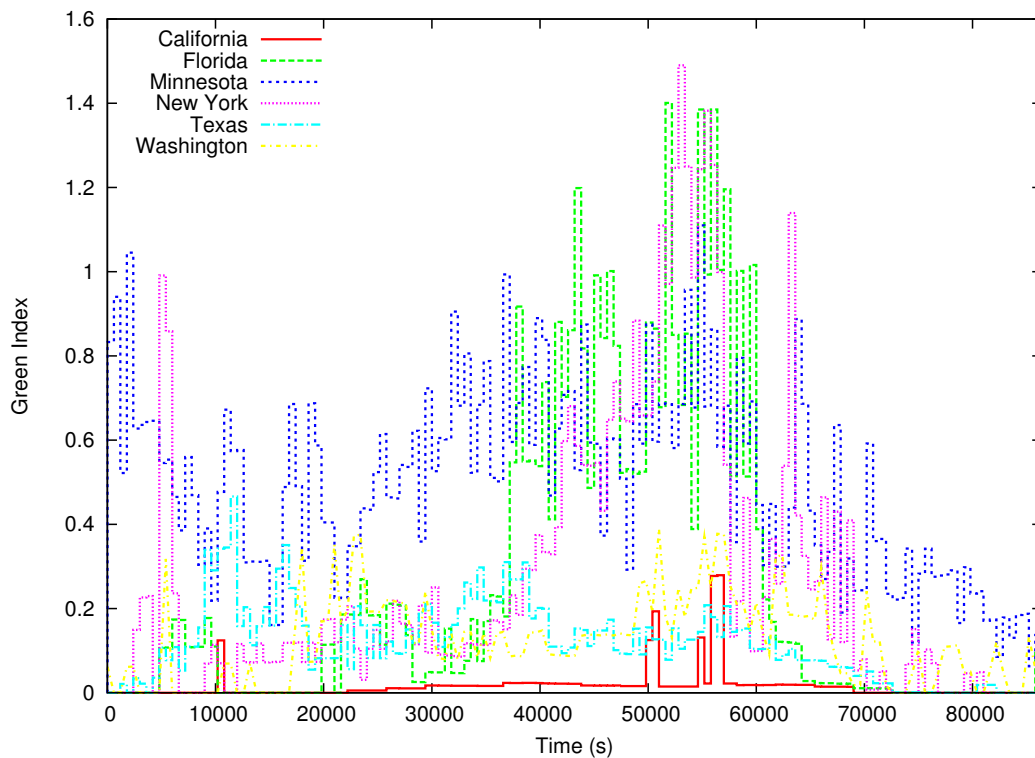

Figure 5.3: Green Index as calculated at all six datacentres.

shown in Figure 5.3. This overall Green Index is updated from the current solar and wind values at 10 minute intervals. For $f(si)$ a linear scaling 250w solar cell is assumed with a maximum output of 250W at 1000 W/m² solar irradiance, as per the solar panel Standard Test Conditions (STC).

The simplified topology used in the simulation model is shown in Figure 5.4. In this topology the network paths are set to have a high available bandwidth of 3Gbps in steady state. For the purposes of these simulations, the paths are simplified to be direct controlled links between the servers and the data centres. This enables the injection of background traffic onto each network path independently of the other paths to simulate real Internet network paths.

In this model, requests into the IPTV system occur from two locations as shown and have inter arrival times that are exponentially distributed based on a diurnal profile found in Yu *et al.* (2006). This is shown in Figure 5.5. It is assumed that requests are received equally from each location to create the total number of requests for a

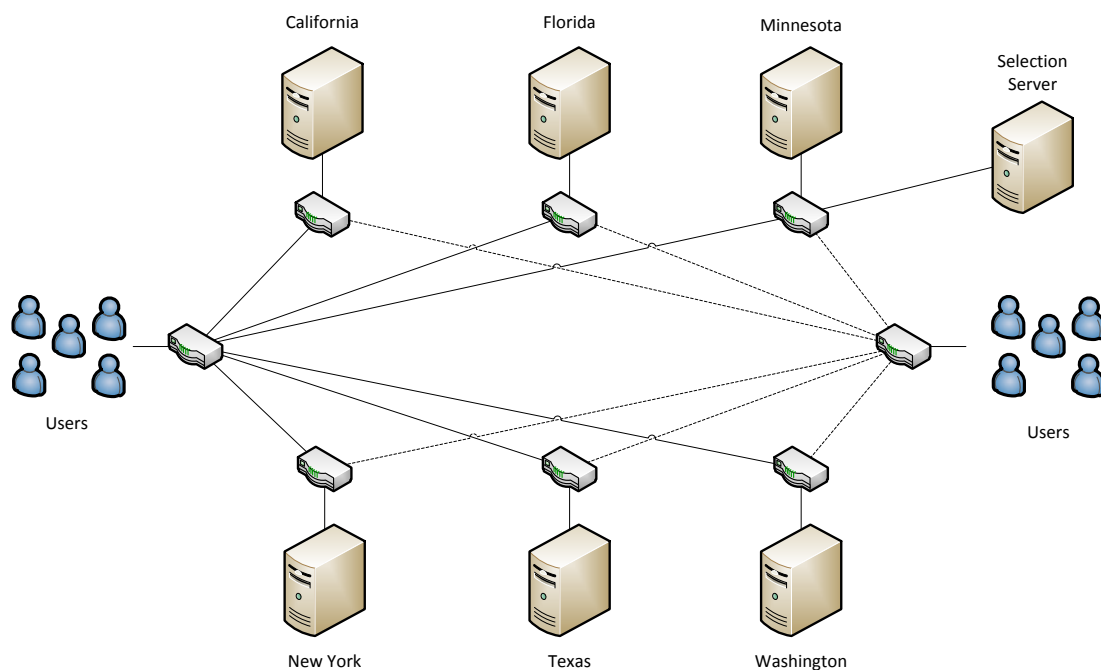

Figure 5.4: Simulation Topology.

given hour but if, for example, varying timezones were involved, a model profiling the requests from each location could easily be built up over time.

The requests are for items that are in a sample content library with a population size of 400. This sample content library was modelled as serving items at 4 bitrates. The bitrates chosen were based on a cross-sample of bitrates used by Netflix [Netflix \(2013\)](#) and are 1Mbps, 1.5Mbps, 2.6Mbps and 3.8Mbps. The popularity of individual items in the content library is based on the Zipf-Mandlebrot [Tang *et al.* \(2007\)](#) distribution, a heavy tailed distribution widely used to model video request patterns.

5.3.2 Experimental Results Analysis

In this section, the results from the baseline comparison algorithms, ABAC and GIAC are presented. This is subsequently followed by an analysis of the performance of both the ABGIAC and GA algorithms.

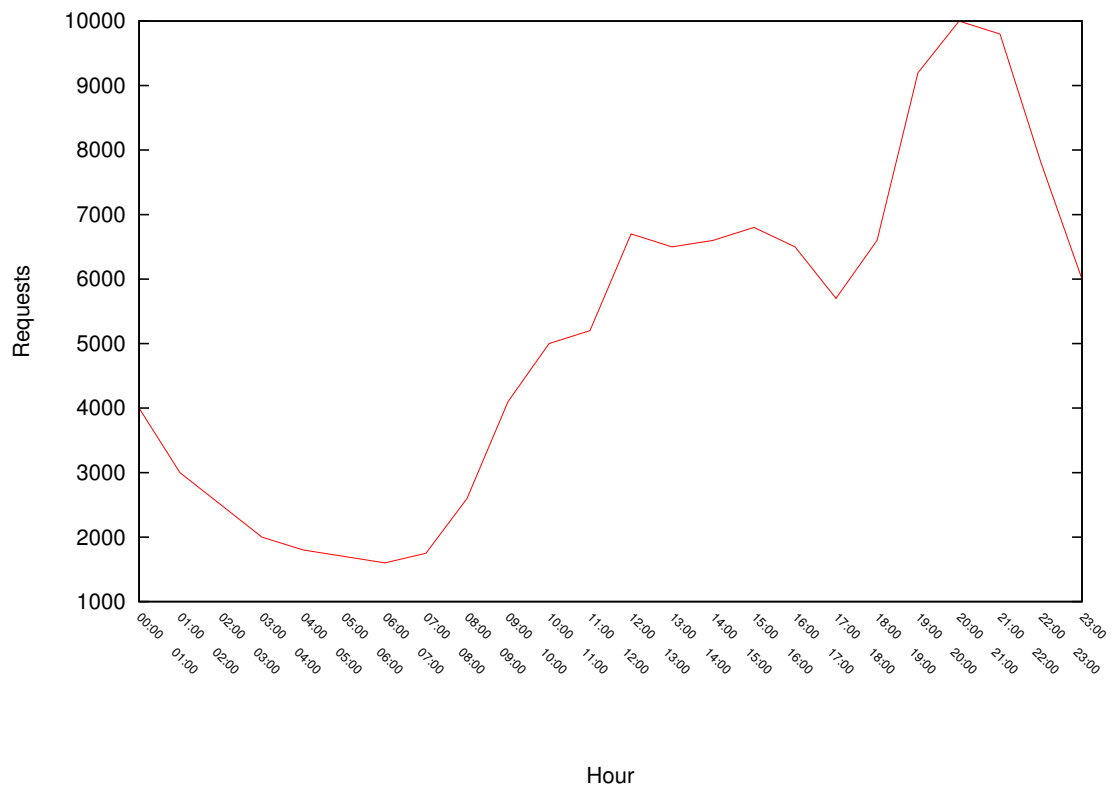

Figure 5.5: Total requests per hour entering the IPTV system.

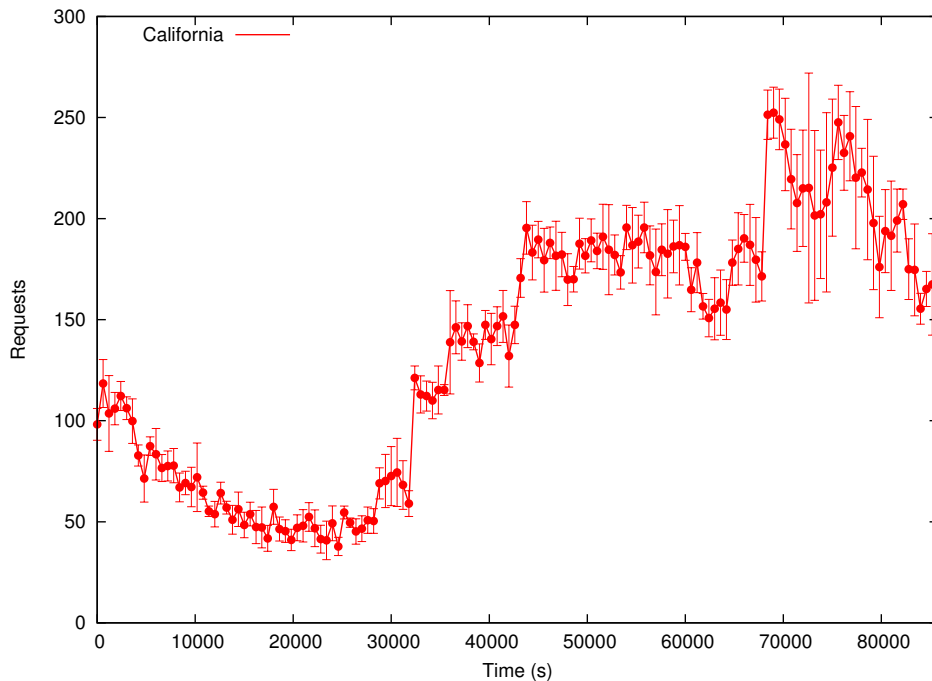

Figure 5.6: Requests serviced at California by ABAC.

5.3.2.1 Evaluation of ABAC and GIAC

Figures 5.7 and 5.9 show the bandwidth between each location and edge router 1 when ABAC and GIAC respectively are used in the Admission Control framework. As Available bandwidth measurements show significant short term variation, and there is an extremely high amount of data points, a moving average taken for 10 minute windows is shown in these graphs. As each edge router has the same request profile, only edge router 1 is included in these graphs, again to prevent overloading the graphs.

In Figures 5.6 and 5.8 the requests that are allocated to each location for both ABAC¹ and GIAC are shown. These graphs are summed at 10 minute intervals for the duration of the simulations. It can be seen that ABAC distributes the requests in accordance with the bandwidth available at each location. In comparison to this, GIAC services requests by focusing solely on the location with the current maximum Green Index.

¹To ensure legibility, only requests serviced at California are shown for ABAC. All 5 other locations are deferred to Appendix A.

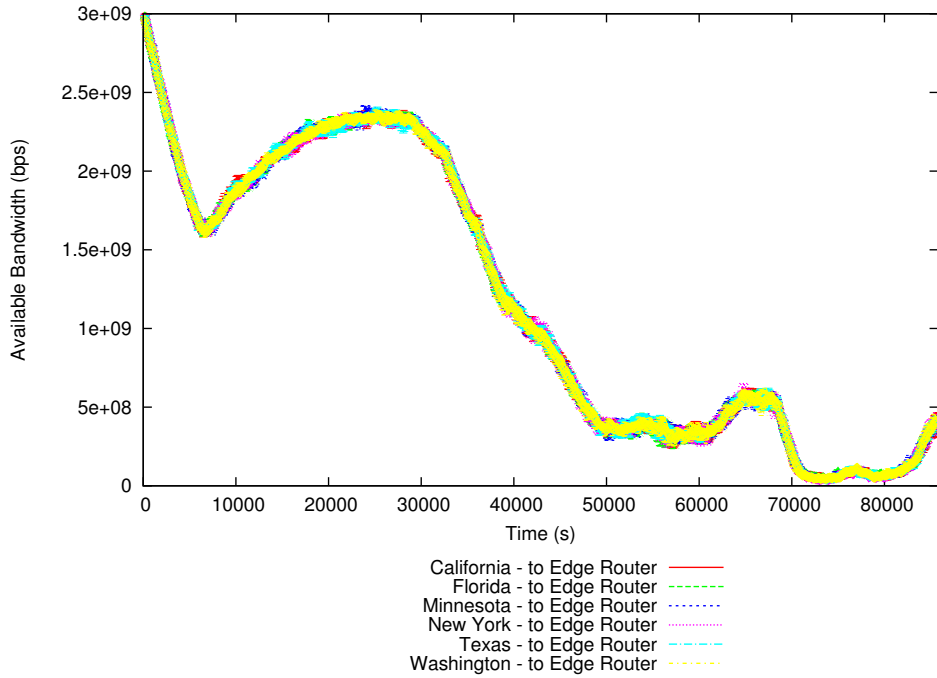

Figure 5.7: Bandwidth between each content server and edge router 1 for ABAC.

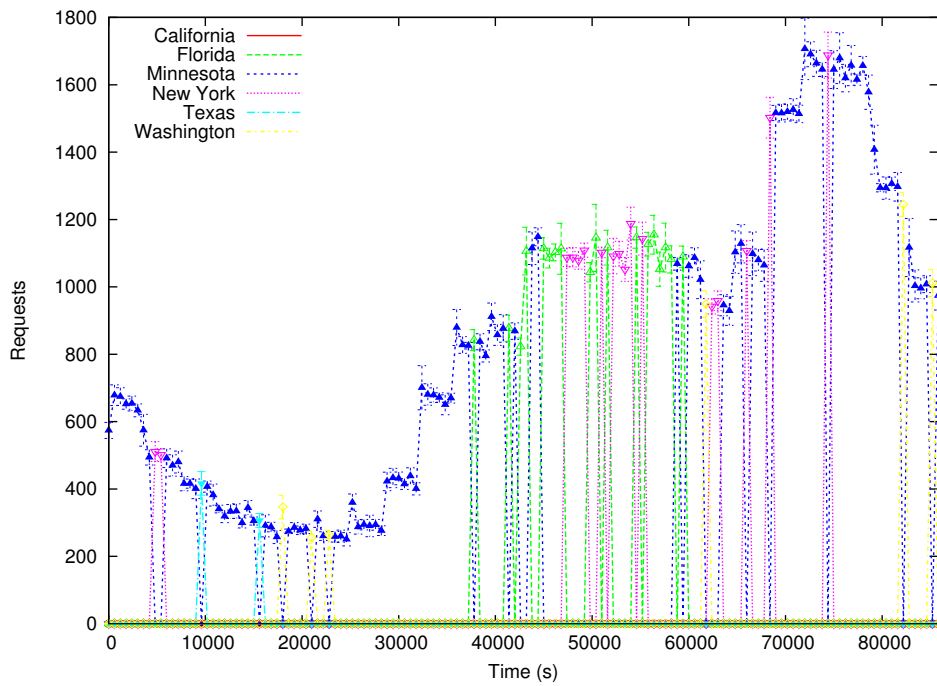

Figure 5.8: Requests serviced at each location by GIAC.

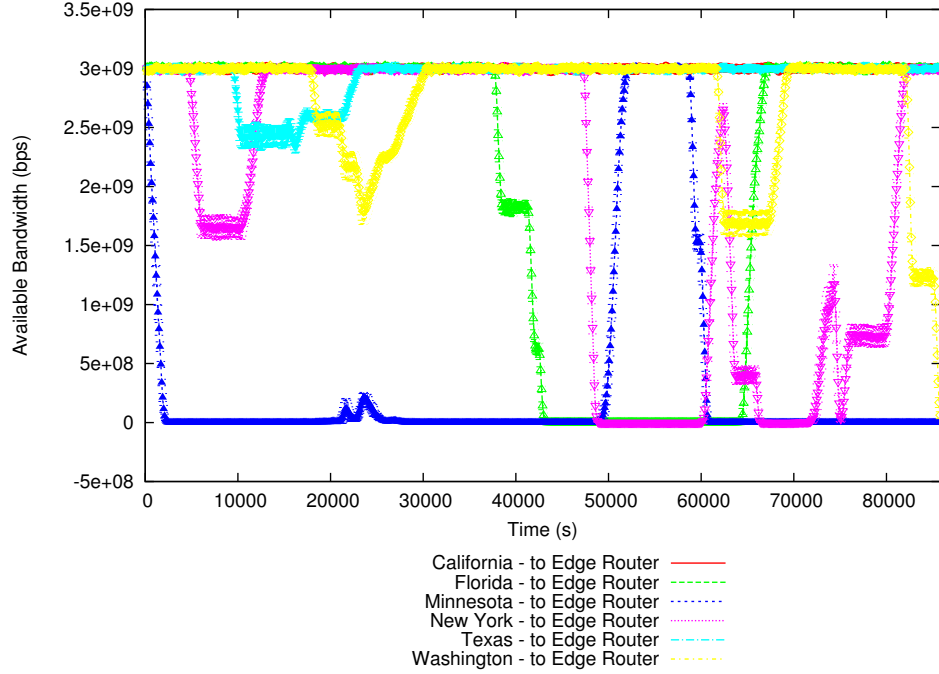

Figure 5.9: Bandwidth between each content server and edge router 1 for GIAC.

ABAC distributes requests proportionately between all six servers, this is reflected in the similar request and bandwidth patterns across servers seen for ABAC in Figures 5.7 and 5.6 respectively. This results in a very even distribution of bandwidth but a significant under exploitation of the Green Energy that is available to be utilised throughout large parts of the day.

GIAC can be seen to always solely focus on the current best Green Index. For large portions of the simulated day, this results in GIAC assigning requests to Minnesota with temporary changes to other servers when their Green Index values become the maximum (as seen in Figure 5.8). This results in a very poor usage of the bandwidth resources, as evidenced by the bandwidth exhaustion present at various locations at different times in Figure 5.9.

Figures 5.10 and 5.11 show the overall performance of each approach with respect to the two objectives that are of interest. As the Green Index at each location varies significantly, using GIAC means the requests are distributed in a manner that saturates the network paths and this results in a high amount of Quality of Service violations but a noticeably superior Green Energy utilisation. A Quality of Service violation is defined

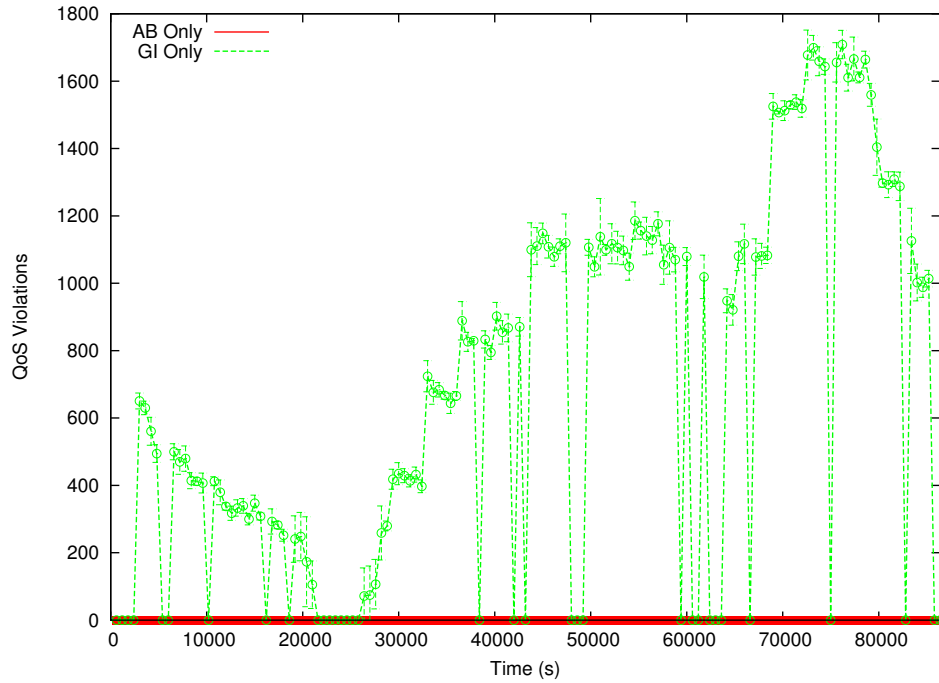

Figure 5.10: Requests experiencing Quality of Service violations for ABAC and GIAC.

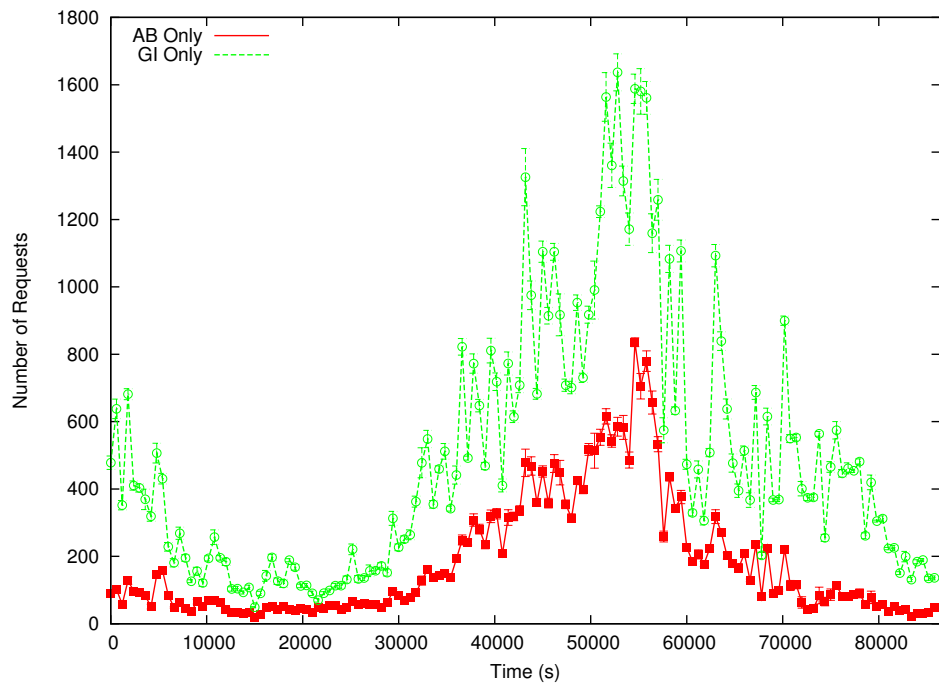

Figure 5.11: Requests Serviced by Green Energy for ABAC and GIAC.

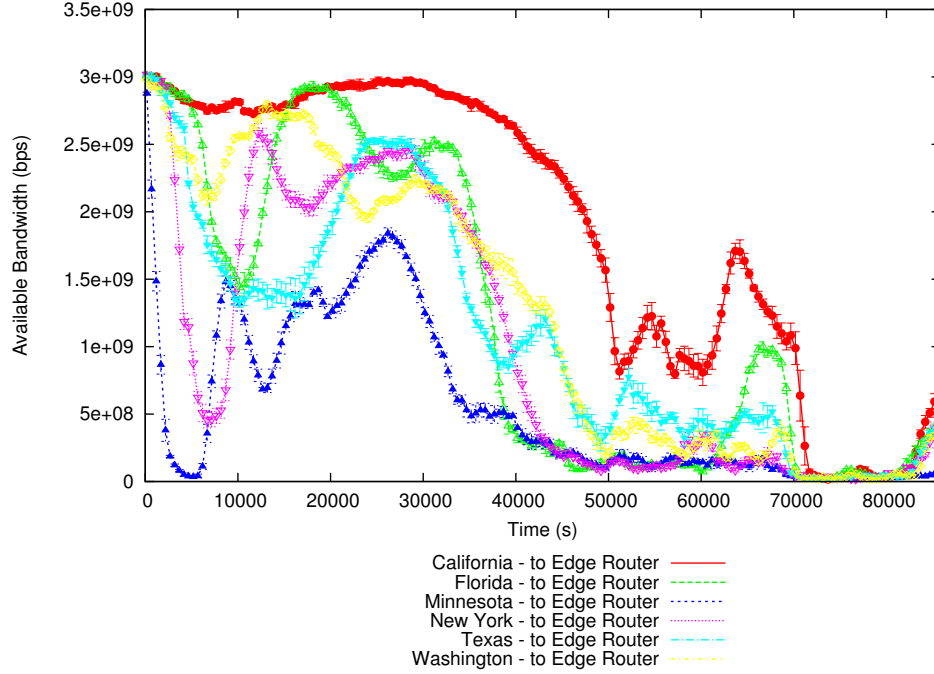

Figure 5.12: Available Bandwidth between each location and edge router 1 when using ABGIAC.

as occurring for a request when the request is on a network path that is experiencing high saturation levels.

This is in contrast to ABAC which does not experience any Quality of Service violations (as it is cognisant of the Available Bandwidth levels) but is unable to maximise Green Energy usage in the manner that GIAC can as Green Index information is not being included in the algorithms server selection process.

5.3.2.2 Evaluation of ABGIAC

The performance of ABGIAC can be seen in Figures 5.12 through 5.15. When these results are compared to the results of ABAC and GIAC, it is easy to observe the benefit of considering both objectives simultaneously. ABGIAC can be seen to prioritise the distribution of requests to servers with a desirable Green Energy level. The Quality of Service requirements can also be seen to be observed as the reducing bandwidth becomes an increasing offset against the positive Green Energy making other servers more attractive overall.

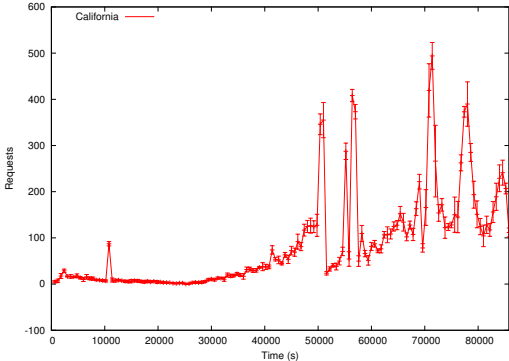

(a) California.

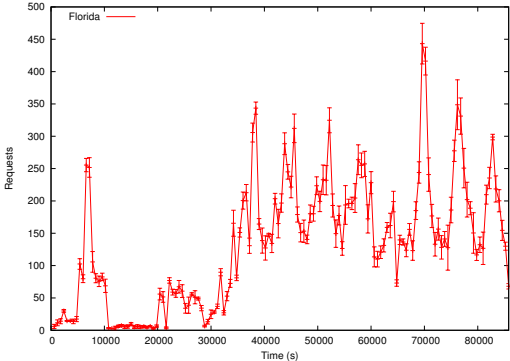

(b) Florida.

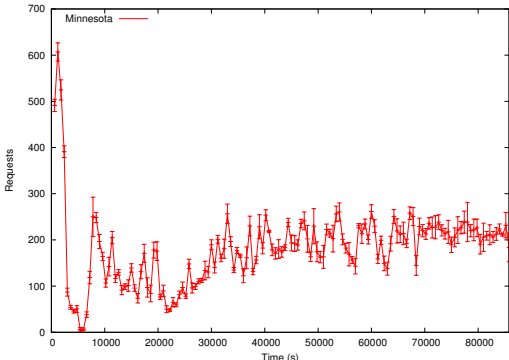

(c) New York.

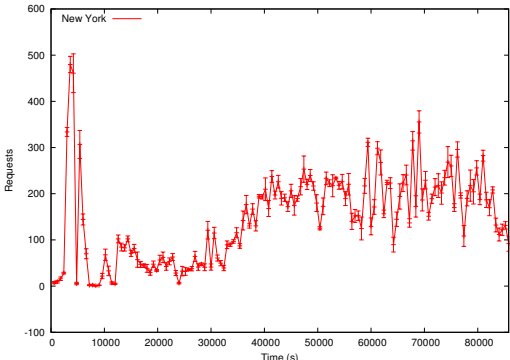

(d) Minnesota.

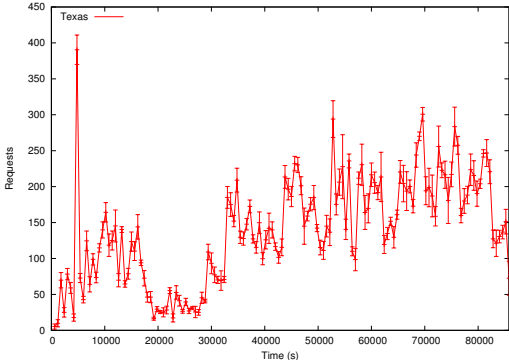

(e) Texas.

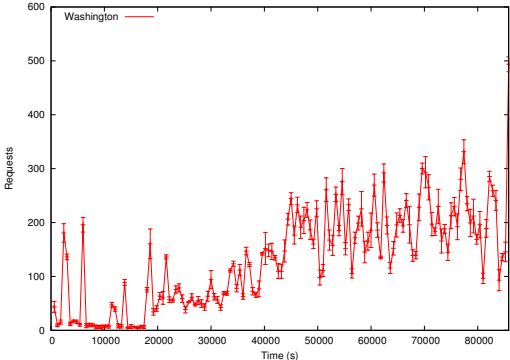

(f) Washington.

Figure 5.13: Requests serviced at all locations for ABGIAC.

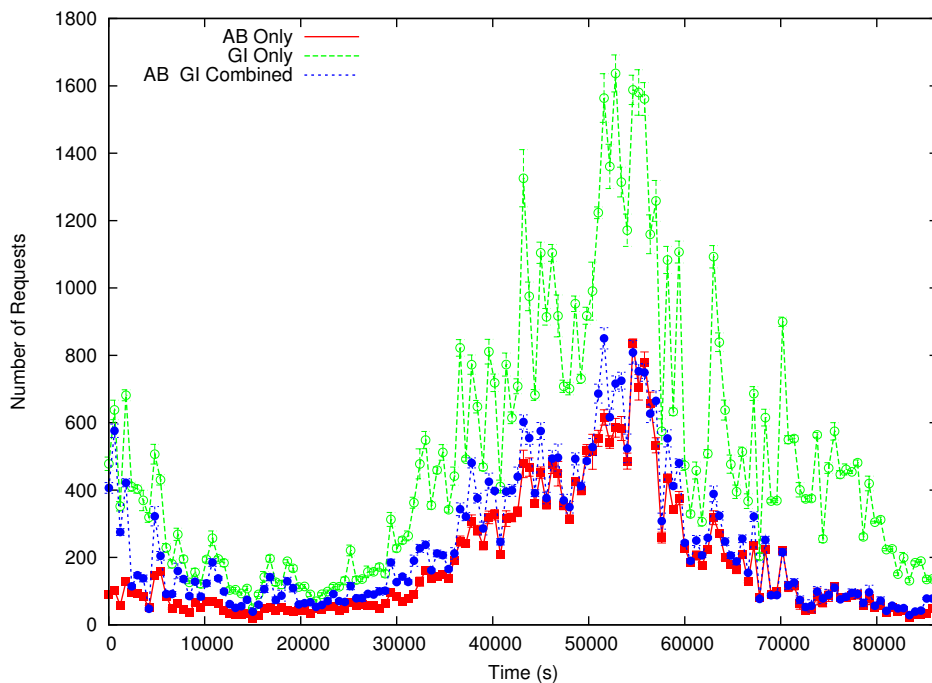

Figure 5.14: Requests serviced using green energy for ABAC, GIAC and ABGIAC.

An example of this can be seen clearly at times less than 10000 seconds in Figures 5.12 and 5.13 when Minnesota initially has the best Green Index (Figure 5.3) and all the Bandwidth levels are on a par, so requests are designated to be served from there. However, as the bandwidth reduces, the favoured server moves briefly to Washington (as it is experiencing a short term spike in Green Energy) and then to New York as it becomes the most appealing overall based on its overall resources for available bandwidth and Green Energy. The request profile around 1000 seconds to 5000 seconds show this (Figure 5.13).

A nice feature of the ABGIAC algorithm is the fact it assigns requests based on probability values. This means the other servers in the system could still potentially be selected even when not the clear favourite. However, this selection is subject to the hard and fast caveat of there being at least enough bandwidth to service the incoming request. This can be seen, for example, in Texas as the requests accepted are above zero, even though the Green Index here is significantly less than that of Minnesota.

Figure 5.14 shows the requests serviced by Green Energy for ABGIAC and compares this to ABAC and GIAC. During the first half of the simulated period, it can be seen

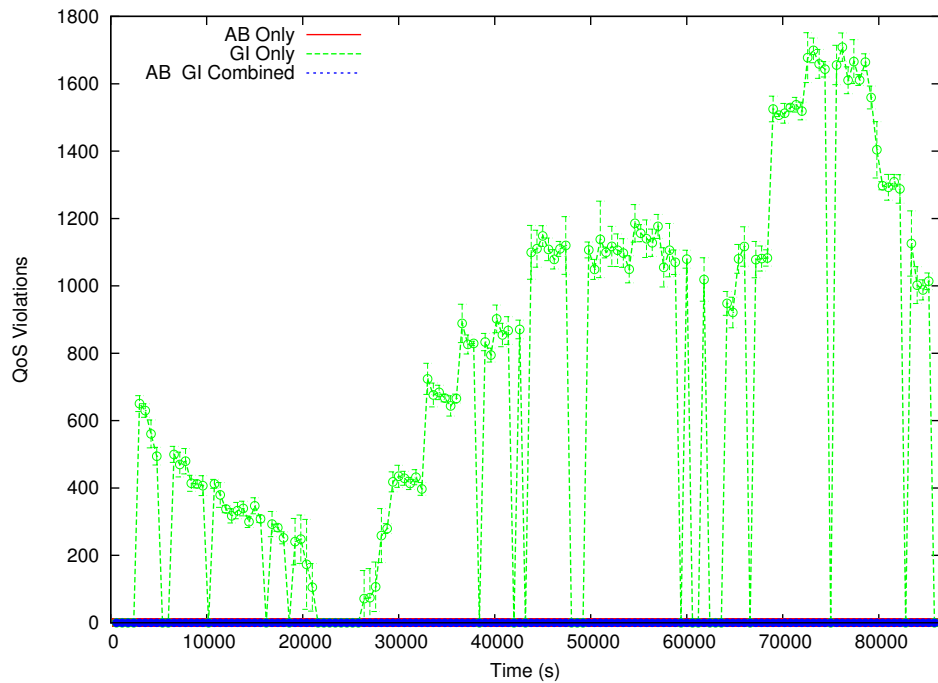

Figure 5.15: Number of requests experiencing Quality of Service violations for ABAC, GIAC and ABGIAC.

that there is an improvement over ABAC in Green Energy usage. As the requests increase into the second half of the day, there is less room to manoeuvre requests to locations with superior Green Energy as the resources of all locations are required. This leads to a similar performance to that of ABAC.

Figure 5.15 shows that this increase in Green Energy usage is not at the expense of Quality of Service concerns as the inclusion of the Available Bandwidth metric ensures that network paths do not become saturated. It is worth noting that as with any multi objective algorithm, there is a trade off between the objectives.

In this research, a trade off has been designed to favour the Quality of Service objective as a location is not considered in the decision making if it does not have at least the minimum bandwidth required to service the request. This is in comparison to the GI objective which simply lessens the likeliness of a location being selected (but does not exclude it) if there is a low amount of Green Energy present at a particular location.

If it was desirable (i.e. more financially beneficial), this balance could be altered to include a location but make it less likely to be chosen if the minimum bandwidth was not present (similar to the GI objective). This would then increase the Green Energy usage but would also increase the Quality of Service violations experienced.

It can be seen from the results that this algorithm focuses on a single most favourable location (with some requests distributed to other locations, depended on their probability ranking). The priority is then shifted to a different location when it has used most of the resources at the first location or another location reports an updated improvement amount of resources.

While this allows the algorithm achieve the stated intention of improving green energy usage and minimising Quality of Service violations, it makes it quite reactive in its performance and this limits it's suitability for resource and capacity planning. To improve this planning capability, an optimisation approach that leverages the information available about request profiles and content popularities is now presented.

The goal of such an approach is to enable capacity planning in the IPTV framework. This capacity planning could be done using the existing resources or by enabling the elastic expansion of servers during peak operational times.

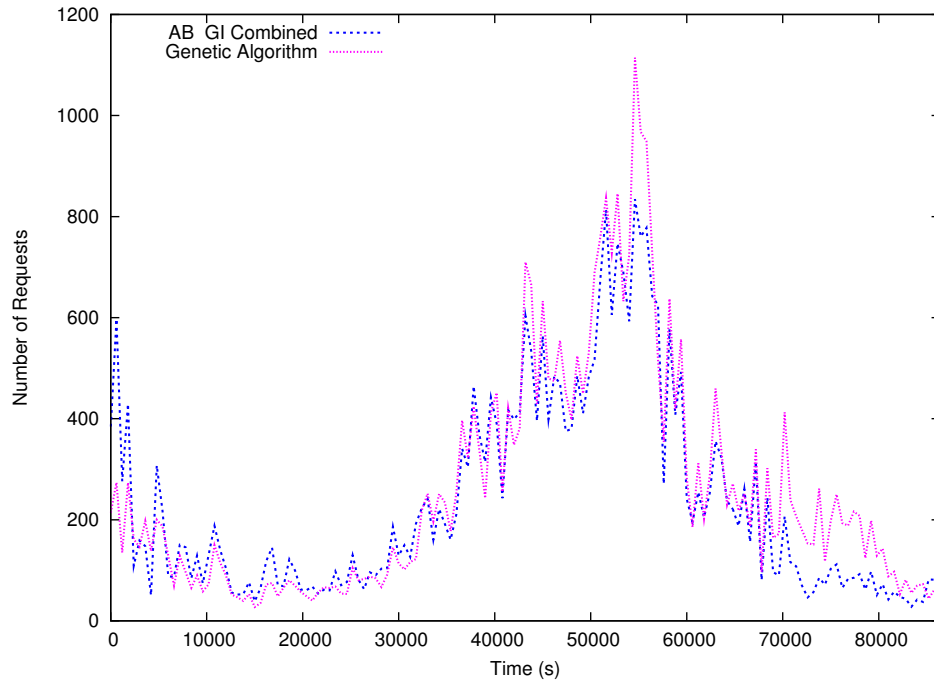

Figure 5.16: Total Green Requests for ABGIAC and GA algorithms.

5.3.2.3 Evaluation of GA

Figure 5.16 shows the amount of requests serviced using green energy for ABGIAC and the genetic algorithm. Prior to 70000 seconds, both ABGIAC and GA have a similar performance in terms of requests served using Green Energy. From Figure 5.17 it can be seen that GA achieves this green energy usage whilst ensuring Quality of Service violations do not occur.

After 70000 seconds (when the amount of requests means that all the resources are required) the genetic algorithm outperforms ABGIAC in terms of green energy usage, but this is at the expense of Quality of Service violations. This is due to ABGIAC being able to react to short term minor changes in bandwidth that occur in such a heavily loaded system. In comparison to this, the genetic algorithm is operating from a defined allocation plan that does not adapt to such short term changes. This highlights the scenario where using ABGIAC is beneficial: where there is short lived frequent changes in the resources available.

In general usage the genetic algorithm performs to the same degree as the instanta-

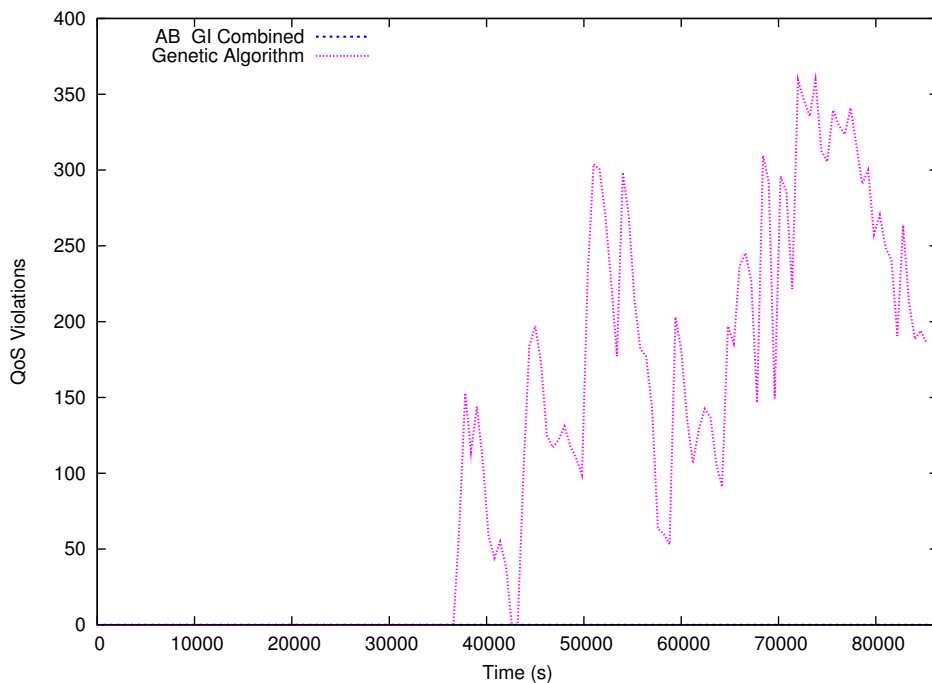

Figure 5.17: Quality of Service violations for ABGIAC and GA algorithms.

neous algorithm but is doing so whilst being aware of the resources. This can be seen in Figure 5.18 where Minnesota (having the best GI early on) is the focus of requests until the bandwidth lessens to a degree that would cause Quality of Service violations and then moves focus to other locations. This focus could be controlled by using the value of α from Equation 5.12 as a potential heuristic to suitably weight the GI and Available Bandwidth to satisfy the priorities defined by the IPTV service provider.

The benefit of the genetic algorithm is that knowing this plan in advance enables a significantly smoother distribution of requests amongst the servers, and allows an IPTV operator to determine if it is worth having a particular location operational for the time duration of the upcoming distribution plan. The corollary of this is also true. By enabling this planning in the IPTV system, elastic expansion can occur and more servers and/or locations could be brought online in times of need. It is felt that if such elastic expansion occurred, the overall performance would improve in times of heavy system usage.

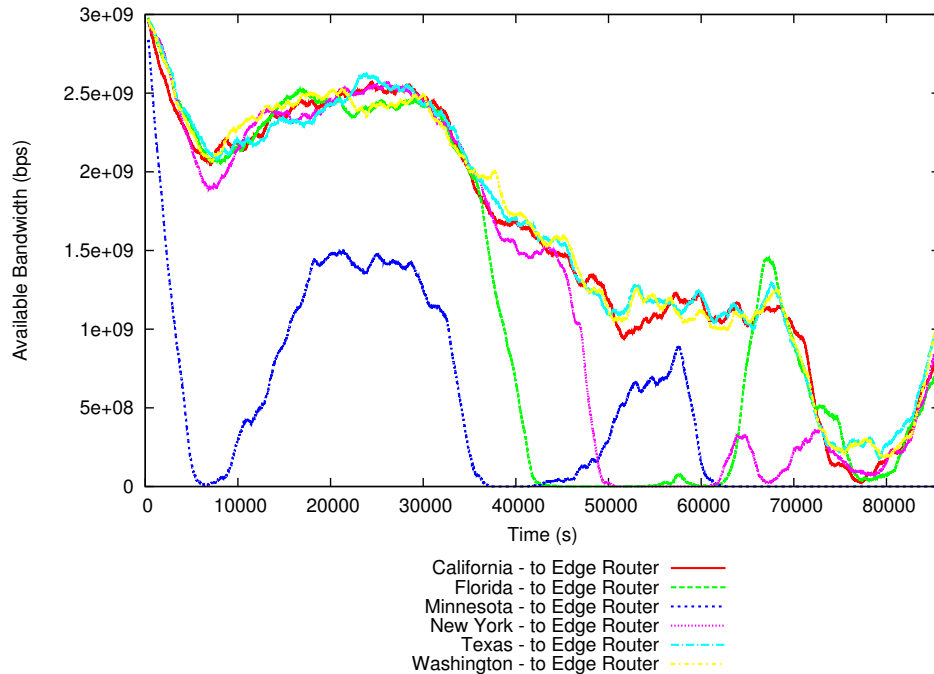

Figure 5.18: Available Bandwidth levels for all locations using the Genetic Algorithm.

5.4 Summary

This chapter addressed the research question of whether end-to-end Available Bandwidth estimation could be of benefit to an IPTV service provider at an inter Service Provider level. An example scenario of maximising Green Energy usage was investigated, due to its ever increasing importance in society.

A model for quantifying the Green Energy percentage present in a data centre was presented, which was called the Green Index. This Green Index was the data that was provided from the external storage provider into the IPTV admission control framework. The necessity for incorporating both this Green Index information and Available Bandwidth estimates when making admission control decisions was demonstrated.

The chapter progressed with the description of a reactive algorithm that combined both available bandwidth estimates and Green Index information. This algorithm uses current reported network conditions and current Green Energy conditions to make a decision about how to distribute arriving requests. The strengths of this algorithm make it more suitable for highly fluctuating and unpredictable network conditions

Following this, an algorithm was presented that is predictive in nature. This algorithm inputs predictions of the future Green Energy along with current network conditions and expected user traffic profiles into a micro Genetic Algorithm to generate a suitable request distribution plan for the IPTV system. This algorithm is shown to be suitable for IPTV systems that are operating in steady network circumstances.

These algorithms form the main contributions of this chapter which can be summarised as both a reactive algorithm suited for unstable, unknown network conditions and a predictive approach that is well suited to stable network conditions and accommodates resource planning by the IPTV service provider. Both these algorithms protect Quality of Service of the accepted requests whilst improving the proportion of Green Energy utilised.

The algorithms in this chapter can be seen to address the third and final research question through providing a benefit to an IPTV service provider when operating at an inter service provider level. This tangible benefit is in the form of an improved overall performance of the system in relation to the defined dual goals of ensuring quality of service whilst increasing green energy usage.

As stated, the focus of this chapter is at an inter service level compared to the intra service level focus of the previous chapter. However, it is felt that the algorithms developed in the previous chapter have the potential also to be adapted for operation at an inter service provider level also.

Chapter 6

Conclusion

The objective of this thesis was to examine and present novel improvements that could be brought to bear upon the management of over the top IPTV service delivery. More specifically, the purpose of this thesis was to evaluate the hypothesis which stated that end-to-end available bandwidth estimation is capable of improving the intra-provider and inter-provider performance of an IPTV Service Provider.

The evaluation of this hypothesis led to the following contributions and conclusions that were absent from existing literature:

- It shows that available bandwidth estimation is suitable for use in an IPTV scenario.
- It provides suggested values and configurations to utilise available bandwidth estimation in an IPTV scenario.
- It shows that benefits can be gained at an intra service provider level in the resource and performance management of an IPTV system through the contribution of novel algorithms to govern both content replication and revenue preservation.
- It shows that benefits can also be gained by an IPTV service provider through the use of available bandwidth estimation when interacting with external partners. This is demonstrated in respect to Green Energy management where two novel algorithms are presented which combine the requirements of ensuring Quality of Service and maximising Green Energy usage.

To evaluate the above hypothesis, it was divided into relevant research questions and a summary of how each research question was evaluated is now given. The benefits to be found through utilisation of the algorithms and approaches presented within the thesis are also presented.

The first research question investigated whether available bandwidth estimation tools were suited to use in an IPTV management system. Chapter 3 addressed this by firstly presenting the result from a comparative investigation that was undertaken into some popular available bandwidth estimation tools. This comparison detailed the characteristics and parameters of these ABETs and the influence of these parameters upon the overall performance of the ABET.

Having obtained an awareness and understanding of the relevant parameters, this chapter continued by examining the effect of changing these parameters when using Available Bandwidth estimates in IPTV admission control. The conclusion was reached that admission control requires up-to-date knowledge of bandwidth availability, therefore any ABET employed must be parameterised for acceptable performance in the given deployment scenario. Part of the contribution of this chapter was the suggestion of appropriate parameterisation for the ABET pathChirp, making it suitable for use in IPTV admission control.

The final contribution of this chapter was the presentation of a framework for IPTV admission control and server selection that used end-to-end Available Bandwidth estimation. This framework was shown to be suitable for use by an over-the-top IPTV service provider and also shown to be capable of ensuring Quality of Service levels were maintained, even in changing network conditions.

Having addressed research question one, Chapter 4 progressed the work by investigating the issues arising from the second research question. This research question related to the improvements which could be achieved by incorporating the use of available bandwidth estimation at an intra service provider level.

To achieve this, the research initially focused upon the replication of content by the IPTV service provider. This content replication occurred between servers that were within the distribution network of the service provider. An algorithm for replication was presented that combined available bandwidth estimation for selecting the best content servers with a targeted selection of the content to be replicated. The resulting algorithm provided a contribution to IPTV service management that was shown to

enable improved resource usage by the content servers as well as an increased availability of the content that was most in demand.

Following on from this, Chapter 4 continued with an investigation into how revenue could be maximised by the IPTV service provider when resources are constrained. An algorithm was developed and presented that incorporated available bandwidth estimation in conjunction with a derived likelihood of the value of predicted upcoming requests.

This algorithm enabled the strategic rejection of low value requests in times of high resource utilisation to allow acceptance of higher value requests while constantly maintaining the underlying requirement of minimising Quality of Service violations. This had the important effect of preserving the incoming revenue for the IPTV service provider.

Upon addressing the suitability of using an ABET in an IPTV scenario and presenting algorithms that leveraged available bandwidth information to improve the intra service provider performance, Chapter 5 progressed the thesis by addressing research question three. This research question was concerned with investigating improvements that could be gained by using available bandwidth at an inter service provider level.

To this end, a scenario of interacting with third party data centres was investigated with a goal of improving green energy usage whilst minimising any adverse impact upon Quality of Service levels.

As a means of achieving this, Chapter 5 commenced with the introduction of a “Green Index”. The Green Index is a method of quantifying the ratio of renewable energy to non renewable at a data centre.

Chapter 5 continued with the presentation of a reactive algorithm that was capable of improving overall green energy usage by the IPTV service provider whilst minimising the Quality of Service violations that were experienced in the system. This algorithm used the available bandwidth estimates generated by the IPTV admission control framework and coupled them with Green Index reports that were received from the storage partners operating the data centres. This data was used to inform the admission control framework when distributing out IPTV service requests.

Following on from this reactive algorithm, an algorithm based upon a micro genetic algorithm was also presented. This algorithm showed similar performance to the

reactive approach mentioned but had the significant benefit of creating a request distribution plan for the upcoming time period. The existence of this request distribution plan allows the IPTV service provider to plan for and improve the utilisation of the resources required within the IPTV system.

6.1 Future Work

As has been mentioned at various junctures throughout this thesis, the possibility exists to further extend and combine the algorithms presented. To conclude this thesis, a discussion of some other potential avenues for further research are presented. The potential avenues discussed relate to changing the core process of how available bandwidth estimates are calculated as well as examining a potential expansion of some of the algorithms developed.

6.1.1 Incorporating Multiple ABETs

The admission control framework initially presented in Chapter 3 was the available bandwidth estimation tool pathChirp as it was shown to be suitable for use in an IPTV scenario. However, this admission control was designed in a manner that was modular with the intention of catering for inclusion of any potentially superior available bandwidth estimation tool. One avenue of research that should be explored is the opportunity to incorporate multiple available bandwidth estimation tools.

This would enable an investigation into the use of different available bandwidth estimation tools to consolidate estimates or help ensure the veracity when network conditions are changing frequently. There is scope within this research to also examine the performance of available bandwidth estimation tools when multiple tools are deployed simultaneously.

6.1.2 Federated CDN Service

The primary form of content distribution considered within this thesis were Content servers / data centres that were internally operated and controlled by the IPTV service provider. However there are other significant forms of content distribution and delivery that are of growing relevance to an over-the-top IPTV service provider. These forms of content distribution are as follows:

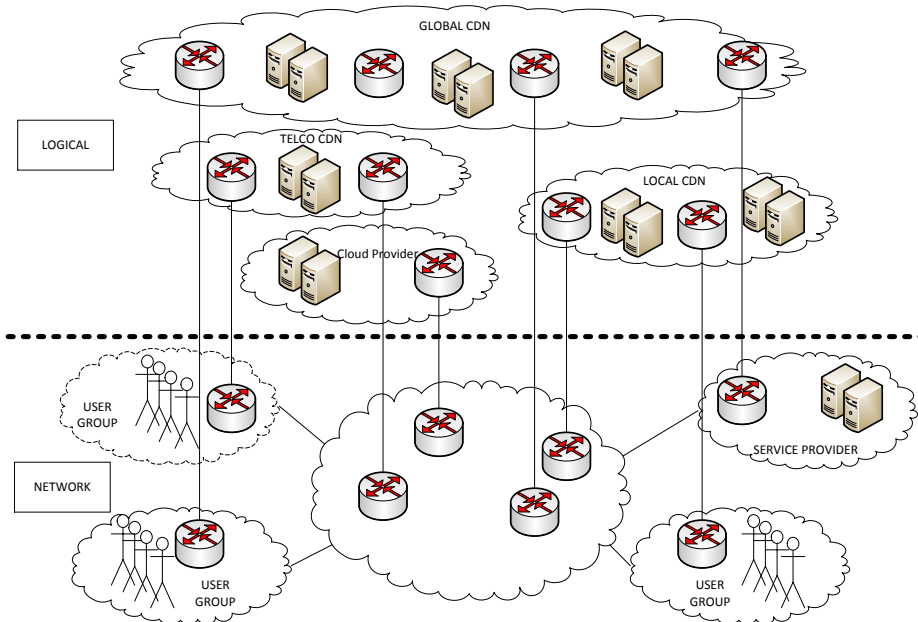

Figure 6.1: Architecture overview showing the stakeholders potentially involved in service delivery and their distribution across the Internet.

- **Global CDN** A Global CDN is the largest scale CDN (e.g. Akamai [Akamai \(2013\)](#)) which can quickly and robustly deliver content on a worldwide scale. It tends to have unparalleled access to resources but as a result has higher utilisation costs.
- **Local CDN** A Local CDN is a CDN that has a national or regional range of operation. As such, it has lower utilisation costs in comparison to a global CDN.
- **Telco CDN** As is increasingly the situation, Internet Access Providers (IAPs) are providing their own multimedia services to their clients meaning a content delivery network (CDN) may exist. Such a CDN is referred to as a Telco CDN.
- **Cloud Storage** A cloud storage provider is designed to grow and shrink in scale to the requirements of the service being operated. Therefore, the strength of a cloud storage provider from an IPTV service providers perspective is its scalability to react to increasing request volumes, making it suited to dealing with short term spikes in request volumes.

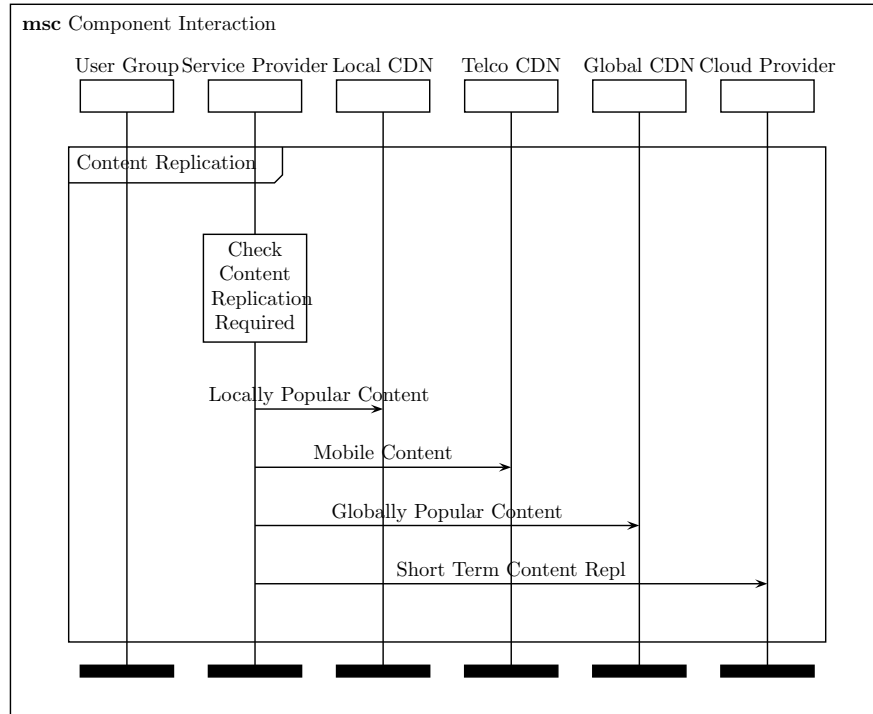

Figure 6.2: Replication process between an IPTV service provider and IPTV federation partners.

Figure 6.1 provides an overview of how these stakeholders might be deployed across many different Autonomous Systems. By expanding the adaptive replication algorithm presented in Chapter 4 to be aware of these other stakeholders, there is the potential for an IPTV provider to improve their resource utilisation. Such an expansion would be based upon a more in-depth request profile being generated by the IPTV service provider.

This request profile would be based on categorising requests into groups based upon the content being requested. Replication could then occur by targeting content to the most appropriate destination. For example, content that is popular in a particular region could be replicated to a local CDN. A high level depiction of this process is presented in Figure 6.2.

To fully exploit any benefits that could be gotten from federating IPTV service delivery, an admission control process utilising available bandwidth estimation would operate in conjunction with the replication process. This admission control process

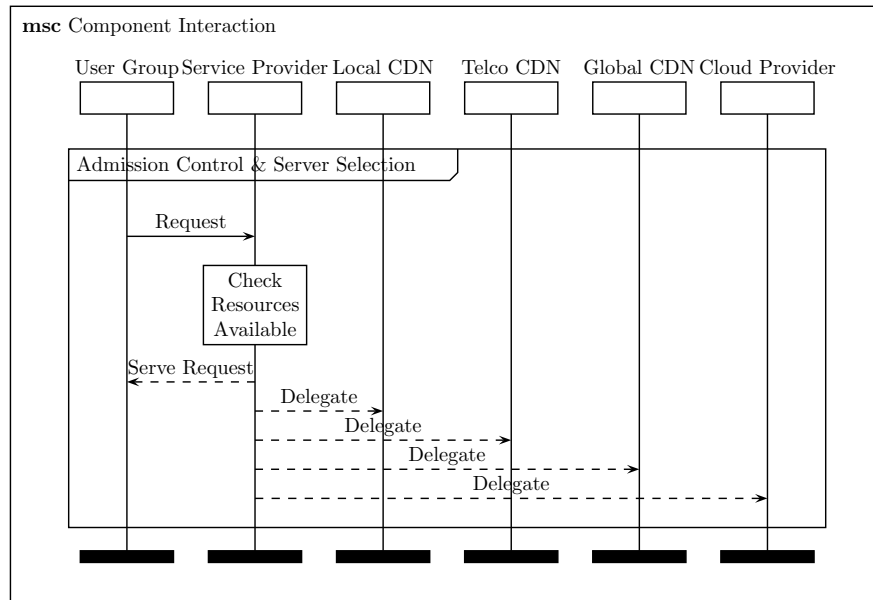

Figure 6.3: Admission Control process between IPTV users and IPTV federation partners.

would place users into groups and statistics would be calculated about these groups to allow for decisions to be made about the best way to serve as many requests as possible whilst minimising costs. The statistics collected would help to assign a request to the most suitable federation partner when delegation was necessary. Figure 6.3 provides an overview of this request delegation concept.

References

- ADNAN, M., SUGIHARA, R. & GUPTA, R. (2012). Energy Efficient Geographical Load Balancing via Dynamic Deferral of Workload. In *IEEE 5th International Conference on Cloud Computing (CLOUD)*,, 188–195. [26](#)
- AGGARWAL, V., FELDMANN, A. & SCHEIDELER, C. (2007). Can isps and p2p users cooperate for improved performance? *ACM SIGCOMM Computer Communication Review*, **37**, 29–40. [23](#)
- AKAMAI (2013). <http://www.akamai.com/> Last accessed: 10/02/2013. [23](#), [124](#)
- ALMES, G., KALIDINDI, S. & ZEKAUSKAS, M. (1999a). A One Way Delay Metric for IPPM. <http://tools.ietf.org/rfc/rfc2679.txt> Last accessed: 25/03/2013. [10](#)
- ALMES, G., KALIDINDI, S. & ZEKAUSKAS, M. (1999b). A One Way Packet Loss Metric for IPPM. <http://tools.ietf.org/rfc/rfc2680.txt> Last accessed: 25/03/2013. [11](#)
- ALMES, G., KALIDINDI, S. & ZEKAUSKAS, M. (1999c). A Round-Trip Delay Metric for IPPM. <http://tools.ietf.org/rfc/rfc2330.txt> Last accessed: 25/03/2013. [11](#)
- ASGHAR, J., LE FAUCHEUR, F. & HOOD, I. (2009). Preserving video quality in iptv networks. *IEEE Transactions on Broadcasting*, **55**, 386–395. [25](#)
- BAGCI, F. (2014). Towards performance and power management of cloud servers. In *11th International Conference on Information Technology: New Generations (ITNG)*, 599–604. [26](#)

- BALASUBRAMANIAM, S., MINERAUD, J., MCDONAGH, P., PERRY, P., MURPHY, L., DONNELLY, W. & BOTVICH, D. (2011). An Evaluation of Parameterized Gradient Based Routing With QoE Monitoring for Multiple IPTV Providers. *IEEE Transactions on Broadcasting*, **57**, 183–194. 12
- BARBAGALLO, D., DI NITTO, E., DUBOIS, D.J. & MIRANDOLA, R. (2010). A bio-inspired algorithm for energy optimization in a self-organizing data center. In *Self-Organizing Architectures*, 127–151, Springer. 26
- BISHOP, G. & WELCH, G. (2001). An introduction to the kalman filter. *Proc of SIG-GRAPH, Course*, **8**, 27599–3175. 21
- BLAKE, S., BLACK, D., CARLSON, M., DAVIES, E., WANG, Z. & WEISS, W. (1998). An Architecture for Differentiated Services. <http://tools.ietf.org/rfc/rfc2475.txt> Last accessed: 25/03/2013. 14
- BOTTA, A., DAVY, A., MESKILL, B. & ACETO, G. (2013). Active techniques for available bandwidth estimation: Comparison and application. In *Data Traffic Monitoring and Analysis*, 28–43, Springer Berlin Heidelberg. iv, 28, 43
- BRADEN, R., SHENKER, S., SHENKER, S., ZHANG, L., ESTRIN, D. & JAMIN, S. (1994). Integrated services in the internet architecture: an overview. <http://tools.ietf.org/rfc/rfc1633.txt> Last accessed: 25/03/2013. 14
- BRADEN, R., ZHANG, L., BERSON, S., HERZOG, S. & JAMIN, S. (1997). Resource ReSerVation Protocol (RSVP) Version 1 Functional Specification. <http://tools.ietf.org/rfc/rfc2205.txt> Last accessed: 25/03/2013. 14, 25
- BRADNER, S. (1991). Benchmarking terminology for network interconnection devices ietf rfc 1242. <https://tools.ietf.org/rfc/rfc1242.txt> Last accessed 19/10/2013. 10
- CABELLOS-APARICIO, A., GARCIA, F. & DOMINGO-PASCUAL, J. (2008). A novel available bandwidth estimation and tracking algorithm. In *IEEE Network Operations and Management Symposium Workshops*, 87–94. 17, 29

-
- CARLSSON, N. & EAGER, D.L. (2010). Server selection in large-scale video-on-demand systems. *ACM Transactions on Multimedia Computing, Communications and Applications*, **6**, 1:1–1:26. 25
- CASE, J., FEDOR, M., SCHOFFSTALL, M. & DAVIN, J. (1988). A simple network management protocol. <https://tools.ietf.org/rfc/rfc1067.txt> Last accessed 19/10/2013. 13
- CASE, J., MCCLOGHRIE, K. & WALDBUSSER, S. (1996). Introduction to community-based snmpv2. <https://tools.ietf.org/rfc/rfc1901.txt> Last accessed 19/10/2013. 13
- CHANDRA, P. & SAHOO, B. (2009). Performance analysis of load balancing algorithms for cluster of video on demand servers. In *IEEE International Advanced Computing Conference*, 408–412. 25
- CHEN, Y., QIU, L., CHEN, W., NGUYEN, L. & KATZ, R.H. (2003). Efficient and adaptive web replication using content clustering. *Selected Areas in Communications, IEEE Journal on*, **21**, 979–994. 22
- CHENG, X., DALE, C. & LIU, J. (2007). Understanding the characteristics of internet short video sharing: Youtube as a case study. *Proceedings of the 7th ACM SIGCOMM Conference on Internet Measurement*. 50, 79
- CIAVATTONI, L., MORTON, A. & RAMACHANDRAN, G. (2003). Standardized active measurements on a tier 1 ip backbone. *IEEE Communications Magazine*, **41**, 90–97. 11
- CLOUDFRONT (2013). <http://aws.amazon.com/cloudfront/> Last accessed: 19/10/2013. 23
- COMER, D.E. (2008). *Computer Networks and Internets*. Prentice Hall Press, Upper Saddle River, NJ, USA, 5th edn. 12
- COTTON, S. & KLEINMANN, A. (2006). Service Specification - IP Television (IPTV), Resource Data Collection, Analysis & Control (RDC) For IP-Based Services. Tech. Rep. 3.5-A.0.0, <http://www.IPDR.org>. 16

- CROCE, D., LEONARDI, E. & MELLIA, M. (2011). Large-scale available bandwidth measurements: Interference in current techniques. *IEEE Transactions on Network and Service Management*, **8**, 361–374. [22](#)
- DAVY, A., BOTVICH, D. & JENNINGS, B. (2008). Revenue optimized IPTV admission control using empirical effective bandwidth estimation. *IEEE Transactions on Broadcasting*, **54**, 599–611. [24](#), [71](#)
- DAVY, A., MESKILL, B. & DOMINGO-PASCUAL, J. (2012). An empirical study of effective capacity throughputs in 802.11 wireless networks. In *IEEE Global Communications Conference (GLOBECOM)*, 1770–1775, IEEE. [iv](#)
- DEMICHELI, C. & CHIMENTO, P. (2002). IP Packet Delay Variation for IP Performance Metrics (IPPM). <http://www.ietf.org/rfc/rfc3393.txt> Last accessed: 09/02/2013. [11](#)
- EARDLEY, P. (2009). Pre-Congestion Notification (PCN) architecture ietf rfc 5559. <https://tools.ietf.org/rfc/rfc5559.txt> Last accessed 27/03/2013. [25](#)
- EKELIN, S., NILSSON, M., HARTIKAINEN, E., JOHNSON, A., MANGS, J.E., MELANDER, B. & BJORKMAN, M. (2006). Real-time measurement of end-to-end available bandwidth using kalman filtering. *Proceedings of IEEE/IFIP Network Operations and Management Symposium*, 73–84. [21](#)
- FENG, Y., LI, B. & LI, B. (2012). Bargaining towards maximized resource utilization in video streaming datacenters. In *Proceedings of IEEE INFOCOM*, 1134–1142. [25](#)
- FIDLER, M. & SANDER, V. (2004). A Parameter based Admission Control For Differentiated Services Networks. *Comput. Netw.*, **44**, 463–479. [24](#)
- GARG, S.K., YEO, C.S. & BUYYA, R. (2011). Green cloud framework for improving carbon efficiency of clouds. In *Euro-Par 2011 Parallel Processing*, 491–502, Springer. [26](#)
- GEORGIOULAS, S., TRIMINTZIOS, P., PAVLOU, G. & HO, K.H. (2005). Measurement-Based Admission Control For Real-time Traffic In IP Differentiated Services Networks. In *Proc. of 12th IEEE International Conference on Telecommunications (ICT)*. [24](#)

-
- GMACH, D., ROLIA, J., BASH, C., CHEN, Y., CHRISTIAN, T., SHAH, A., SHARMA, R. & WANG, Z. (2010). Capacity planning and power management to exploit sustainable energy. In *International Conference on Network and Service Management (CNSM)*, 96–103. [26](#)
- GOLDONI, E. & ROSSI, G. (2008). Improving Available Bandwidth Estimation Using Averaging Filtering Techniques. *Technical Report, University of Pavia, 2008*. [19](#)
- GOLDONI, E. & SCHIVI, M. (2010). End-to-end available bandwidth estimation tools, an experimental comparison. In F. Ricciato, M. Mellia & E. Biersack, eds., *Traffic Monitoring and Analysis*, vol. 6003 of *Lecture Notes in Computer Science*, 171–182, Springer Berlin Heidelberg. [22](#)
- GOLDONI, E., ROSSI, G. & TORELLI, A. (2009). Assolo, a new method for available bandwidth estimation. *International Conference on Internet Monitoring and Protection*, **0**, 130–136. [19](#), [29](#)
- GREENGRASS, J., EVANS, J. & BEGEN, A. (2009). Not all packets are equal, part i: Streaming video coding and sla requirements. *IEEE Internet Computing*, **13**, 70–75. [12](#)
- GUERRERO, C.D. & LABRADOR, M.A. (2010). On the applicability of available bandwidth estimation techniques and tools. *Computer Communications*, **33**, 11–22. [21](#)
- GUPTA, R., PULIPAKA, A., SEELING, P., KARAM, L.J. & REISSLEIN, M. (2012a). H.264 coarse grain scalable (cgs) and medium grain scalable (mgs) encoded video: A trace based traffic and quality evaluation. *Broadcasting, IEEE Transactions on*, **58**, 428–439. [16](#)
- GUPTA, R., PULIPAKA, A., SEELING, P., KARAM, L.J. & REISSLEIN, M. (2012b). H.264 Coarse Grain Scalable (CGS) and Medium Grain Scalable (MGS) Encoded Video: A Trace Based Traffic and Quality Evaluation. *IEEE Transactions on Broadcasting*, **58**, 428–439. [32](#)
- HEI, X., LIANG, C., LIANG, J., LIU, Y. & ROSS, K. (2007). A measurement study of a large-scale p2p iptv system. *Multimedia, IEEE Transactions on*, **9**, 1672–1687. [23](#)

- HU, N. & STEENKISTE, P. (2003). Evaluation and characterization of available bandwidth probing techniques. *IEEE Journal on Selected Areas in Communications*, **21**, 879–894. 20
- ILYAS, M., RAZA, S., CHEN, C.C., UZMI, Z. & CHUAH, C.N. (2012). Red-bl: Energy solution for loading data centers. In *Proceedings of IEEE INFOCOM*, 2866–2870. 26
- INTERNATIONAL TELECOMMUNICATION UNION - TELECOMMUNICATIONS STANDARDISATION SECTOR (ITU-T) (2013). <http://www.itu.int/rec/T-REC-H/en> Last accessed: 09/02/2013. 15
- ISO/IEC MOVING PICTURE EXPERTS GROUP (MPEG) (2013). <http://mpeg.chiariglione.org/standards> Last accessed: 09/02/2013. 15
- JAIN, M. & DOVROLIS, C. (2002). Pathload: A measurement tool for end-to-end available bandwidth. *Proceedings of Passive and Active Measurements Workshop*, 14–25. 19
- JAMIN, S., SHENKER, S. & DANZIG, P. (1997). Comparison Of Measurement-Based Admission Control Algorithms For Controlled-Load Service. In *INFOCOM '97. Sixteenth Annual Joint Conference of the IEEE Computer and Communications Societies. Proceedings IEEE*, vol. 3, 973–980 vol.3. 24
- KELLY, F. (1996). Notes on effective bandwidths. *Stochastic networks: theory and applications*, 141–168. 10
- KIM, H.J. & CHOI, S.G. (2010). A study on a QoS/QoE correlation model for QoE evaluation on IPTV service. In *The 12th International Conference on Advanced Communication Technology*, vol. 2, 1377–1382. 12
- KISHIGAMI, J. (2007). The Role of QoE on IPTV Services style. In *Ninth IEEE International Symposium on Multimedia*, 11–13. 12
- KOSTIĆ, D., RODRIGUEZ, A., ALBRECHT, J. & VAHDAT, A. (2003). Bullet: High bandwidth data dissemination using an overlay mesh. *ACM SIGOPS Operating Systems Review*, **37**, 282–297. 23

-
- KRISHNAKUMAR, K. (1990). Micro-genetic algorithms for stationary and non-stationary function optimization. *Proceedings of SPIE, Intelligent Control and Adaptive Systems*, **1196**, 289–296. [99](#)
- LATRÉ, S. & DE TURCK, F. (2013). Joint in-network video rate adaptation and measurement-based admission control: Algorithm design and evaluation. *Journal of Network and Systems Management*, **21**, 588–622. [25](#)
- LI, M., WU, Y.L. & CHANG, C.R. (2013). Available bandwidth estimation for the network paths with multiple tight links and bursty traffic. *Journal of Network and Computer Applications*, **36**, 353–367. [21](#)
- LIU, Y., GUO, Y. & LIANG, C. (2008). A survey on peer-to-peer video streaming systems. *Peer-to-peer Networking and Applications*, **1**, 18–28. [23](#)
- LIU, Y., WANG, Y. & DU, H. (2010). Strong cache consistency on world wide web. In *Advanced Computer Theory and Engineering (ICACTE), 2010 3rd International Conference on*, vol. 5, V5–62 –V5–65. [22](#)
- LIU, Z., LIN, M., WIERMAN, A., LOW, S.H. & ANDREW, L.L. (2011). Greening geographical load balancing. *Proceedings of the ACM SIGMETRICS joint international conference on Measurement and modeling of computer systems*, 233–244. [26](#)
- MAGHAREI, N. & REJAIE, R. (2009). Prime: Peer-to-peer receiver-driven mesh-based streaming. *IEEE/ACM Transactions on Networking (TON)*, **17**, 1052–1065. [23](#)
- MATHIS, M. & ALLMAN, M. (2001). A Framework for Defining Empirical Bulk Transfer Capacity Metrics. <http://www.ietf.org/rfc/rfc3148.txt> Last accessed: 05/12/2013. [10](#)
- MCCLOGHRIE, K. & ROSE, M. (1991). Management information base for network management of tcp/ip-based internets: Mib-ii. <https://tools.ietf.org/rfc/rfc1213.txt> Last accessed 19/10/2013. [13](#)
- MENTH, M., MILBRANDT, J. & OECHSNER, S. (2004). Experience-Based Admission Control (EBAC). *Computers and Communications, IEEE Symposium on*, **2**, 903–910. [24](#)

- MESKILL, B., DAVY, A. & JENNINGS, B. (2010). Impact of topology complexity on congestion-based end-to-end available bandwidth estimation tools. In *10th Information Technology and Telecommunications Conference*. v, 28
- MESKILL, B., DAVY, A. & JENNINGS, B. (2011). Server selection and admission control for IP-based video on demand using available bandwidth estimation. In *36th IEEE Conference on Local Computer Networks*, 255–258. iv, 28
- MESKILL, B., DAVY, A. & JENNINGS, B. (2012). Revenue-Maximizing Server Selection and Admission Control for IPTV Content Servers using Available Bandwidth Estimates. *IEEE/IFIP Network Operations and Management Symposium*, 319–326. iv, 58
- MESKILL, B., BALASUBRAMANIAM, S., BRENNAN, R., FEENEY, K. & JENNINGS, B. (2013). Federation Lifecycle Management Incorporating Coordination of Bio-inspired Self-management Processes. *Journal of Network and Systems Management*, 1–27. iv, 58
- MESKILL, B., CARROLL, R., DAVY, A., BALASUBRAMANIAM, S. & JENNINGS, B. (2015). Preferring Data Centres with Renewable Energy Sources when Serving Streaming Video Content. *Sustainable Computing*. iv, 90
- NAM, S.Y., KIM, S. & SUNG, D.K. (2008). Measurement-Based Admission Control At Edge Routers. *IEEE/ACM Trans. Netw.*, **16**, 410–423. 24
- NETFLIX (2013). <http://www.netflix.com> Last accessed: 10/02/2013. 1, 105
- NGUYEN, U.C., TRAN, D.T. & NGUYEN, G.V. (2014). A taxonomy of applying filter techniques to improve the available bandwidth estimations. In *Proceedings of the 8th International Conference on Ubiquitous Information Management and Communication*, 18:1–18:8. 22
- NYGREN, E., SITARAMAN, R.K. & SUN, J. (2010). The akamai network: A platform for high-performance internet applications. *ACM SIGOPS Operating Systems Review*, **44**, 2–19. 23
- OPNET MODELER (2013). http://www.opnet.com/solutions/network_rd/modeler.html Last accessed: 27/03/2013. 29, 49, 79, 103

-
- OROSZ, P., SKOPK, T., NAGY, Z., VARGA, P. & GYIMTHI, L. (2014). A case study on correlating video qos and qoe. In *IEEE Network Operations and Management Symposium (NOMS)*, 1–5. [12](#)
- PEOPLES, C., PARR, G., MCCLEAN, S., MORROW, P. & SCOTNEY, B. (2013). Energy aware scheduling across “green” cloud data centres. In *IFIP/IEEE International Symposium on Integrated Network Management*, 876–879. [26](#)
- RAHRER, T., FAINDRA, R. & WRIGHT, S. (2006). Triple-play services quality of experience (QoE) requirements. Technical Report TR-126, DSL-Forum, Architecture & Transport Working Group. [81](#)
- RIBEIRO, V.J., RIEDI, R.H., BARANIUK, R.G., NAVRATIL, J. & COTTRELL, L. (2003). pathchirp: Efficient available bandwidth estimation for network paths. In *In Passive and Active Measurement Workshop*. [18](#), [29](#)
- SCHWARZ, H., MARPE, D. & WIEGAND, T. (2007). Overview of the scalable video coding extension of the h.264/avc standard. *Circuits and Systems for Video Technology, IEEE Transactions on*, **17**, 1103 –1120. [16](#)
- SEDIGHIZAD, M., SEYFE, B. & NAVAIE, K. (2012). Mr-bart: Multi-rate available bandwidth estimation in real-time. *Journal of Network and Computer Applications*, **35**, 731 – 742. [21](#)
- SEELING, P. & REISSLEIN, M. (2012). Video transport evaluation with H.264 video traces. *IEEE Communications Surveys and Tutorials*, Traces available at <http://trace.eas.asu.edu>. [32](#)
- SEELING, P., REISSLEIN, M. & KULAPALA, B. (2004). Network performance evaluation using frame size and quality traces of single-layer and two-layer video: A tutorial. *IEEE Communications Surveys Tutorials*, **6**, 58 –78. [50](#), [79](#)
- SHRIRAM, A. & KAUR, J. (2007). Empirical evaluation of techniques for measuring available bandwidth. *IEEE International Conference on Computer Communications*, 2162–2170. [22](#), [29](#), [35](#)
- SKY PLAYER (2013). <http://skyplayer.sky.com/vod/page/default/home.do> Last accessed: 10/02/2013. [1](#)

-
- SOPCAST (2013). <http://www.sopcast.com/> Last accessed: 10/02/2013. 23
- STRAUSS, J., KATABI, D. & KAASHOEK, F. (2003). A measurement study of available bandwidth estimation tools. *Proceedings of the 3rd ACM SIGCOMM conference on Internet measurement*, 39–44. 18, 20
- SULLIVAN, G., OHM, J., HAN, W.J., WIEGAND, T. & WIEGAND, T. (2012). Overview of the high efficiency video coding (hevc) standard. *Circuits and Systems for Video Technology, IEEE Transactions on*, **22**, 1649–1668. 16
- SUTHAHARAN, S. & KUMAR, S. (2008). Measuring available bandwidth: pathchirp’s chirp train structure remodeled. In *Australasian Telecommunication Networks and Applications Conference*, 379–384. 19, 29
- TAKAHASHI, A., HANDS, D. & BARRIAC, V. (2008). Standardization activities in the ITU for a QoE assessment of IPTV. *IEEE Communications Magazine*, **46**, 78–84. 12
- TANENBAUM, A.S. & WETHERALL, D. (2011). *Computer networks*. Prentice Hall, 5th edn. 10
- TANG, W., FU, Y., CHERKASOVA, L. & VAHDAT, A. (2007). Modeling and generating realistic streaming media server workloads. *Computer Networks*, **51**, 336 – 356. 105
- TRAN, H., HOCEINI, S., MELLOUK, A., PEREZ, J. & ZEADALLY, S. (2014). Qoe-based server selection for content distribution networks. *IEEE Transactions on Computers*, **63**, 2803–2815. 25
- VAKALI, A. & PALLIS, G. (2003). Content delivery networks: status and trends. *IEEE Internet Computing*, **7**, 68–74. 23
- VAN DER AUWERA, G., DAVID, P. & REISSLEIN, M. (2008). Traffic characteristics of h.264/avc variable bit rate video. *Communications Magazine, IEEE*, **46**, 164 –174. 16
- WALDBUSSER, S. (2006). Remote network monitoring management information base version 2. <https://tools.ietf.org/rfc/rfc4502.txt> Last accessed 19/10/2013. 13

- WIEGAND, T., SULLIVAN, G., BJONTEGAARD, G. & LUTHRA, A. (2003). Overview of the h.264/avc video coding standard. *Circuits and Systems for Video Technology, IEEE Transactions on*, **13**, 560–576. 15
- WROCLAWSKI, J. (1997). The Use Of RSVP With IETF Integrated Services. <https://tools.ietf.org/rfc/rfc2210.txt> Last accessed 27/03/2013. 14
- WU, Y., WU, C., LI, B., ZHANG, L., LI, Z. & LAU, F.C.M. (2012). Scaling social media applications into geo-distributed clouds. In *Proceedings of IEEE INFOCOM*, 684–692. 26
- XU, D. & QIAN, D. (2008). A bandwidth adaptive method for estimating end-to-end available bandwidth. In *11th IEEE International Conference on Communication Systems*, 543–548. 18
- YOUTUBE (2013). <http://www.youtube.com> Last accessed: 10/02/2013. 1
- YU, H., ZHENG, D., ZHAO, B.Y. & ZHENG, W. (2006). Understanding user behavior in large-scale video-on-demand systems. *SIGOPS Operating Systems Review*, **40**, 333–344. 45, 104
- YUSOH, Z. & TANG, M. (2010). A penalty-based genetic algorithm for the composite saas placement problem in the cloud. In *IEEE Congress on Evolutionary Computation*, 1–8. 26
- ZHANG, X., LIU, J., LI, B. & YUM, Y.S. (2005). Coolstreaming/donet: a data-driven overlay network for peer-to-peer live media streaming. *INFOCOM 2005. 24th Annual Joint Conference of the IEEE Computer and Communications Societies. Proceedings IEEE*, **3**, 2102 – 2111 vol. 3. 23
- ZHANG, Y., WANG, Y. & WANG, X. (2011). Greenware: Greening cloud-scale data centers to maximize the use of renewable energy. In F. Kon & A.M. Kermarrec, eds., *Middleware 2011*, vol. 7049 of *Lecture Notes in Computer Science*, 143–164, Springer Berlin Heidelberg. 26
- ZITZLER, E. & THIELE, L. (1998). Multiobjective optimization using evolutionary algorithms a comparative case study. In *Parallel problem solving from nature PPSN V*, 292–301, Springer. 26

List of Acronyms

AB	Available Bandwidth
ABET	Available Bandwidth Estimation Tool
ABGIAC	Available Bandwidth and Green Index based Admission Control
AC	Admission Control
bps	bits per second
BTC	Bulk Transfer Capacity
CBR	Constant Bit Rate
CDN	Content Delivery Network
DiffServ	Differentiated Services
DSCP	DiffServ Code Point
EBAC	Experience Based Admission Control
GA	Genetic Algorithm
GI	Green Index
GIAC	Green Index based Admission Control
ICT	Information and Communications Technology
IEC	International Electrotechnical Commission
IETF	Internet Engineering Task Force

REFERENCES

IntServ	Integrated Services
IP	Internet Protocol
IPTV	Internet Protocol TeleVision
ISO	International Organization for Standardization
ITU-T	International Telecommunication Union - Telecommunication Standardization Sector
MBAC	Measurement Based Admission Control
Mbps	Megabits per second
MIB	Management Information Base
MTU	Maximum Transmission Unit
OTT	Over-The-Top
P2P	Peer to Peer
PBAC	Parameter Based Admission Control
PCN	Pre Congestion Notification
PGM	Probe Gap Model
PHB	Per Hop Behaviour
PRM	Probe Rate Model
QoE	Quality of Experience
QoS	Quality of Service
RMON	Remote Network Monitoring
RSVP	Resource Reservation Protocol
SHE	Super Head End
SLA	Service Level Agreement

REFERENCES

SNMP	Simple Network Management Protocol
VBR	Variable Bit Rate
VHO	Video Hub Office
VoD	Video on Demand
VoIP	Voice over IP
VSO	Video Sorting Office

Appendix A

Supplementary Graphs

This appendix supplements Section [5.3.2.1](#) and presents the requests serviced by each location by the ABAC algorithm. By its nature, the ABAC algorithm operates similarly at each location so the locations are presented in individual graphs for legibility.

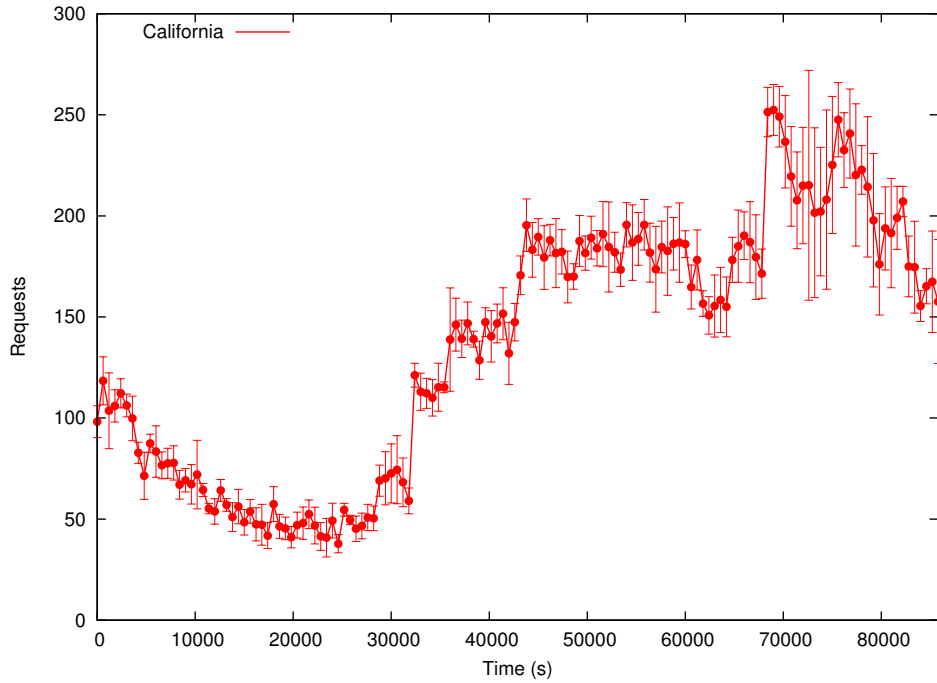

Figure A.1: Requests serviced at California by ABAC.

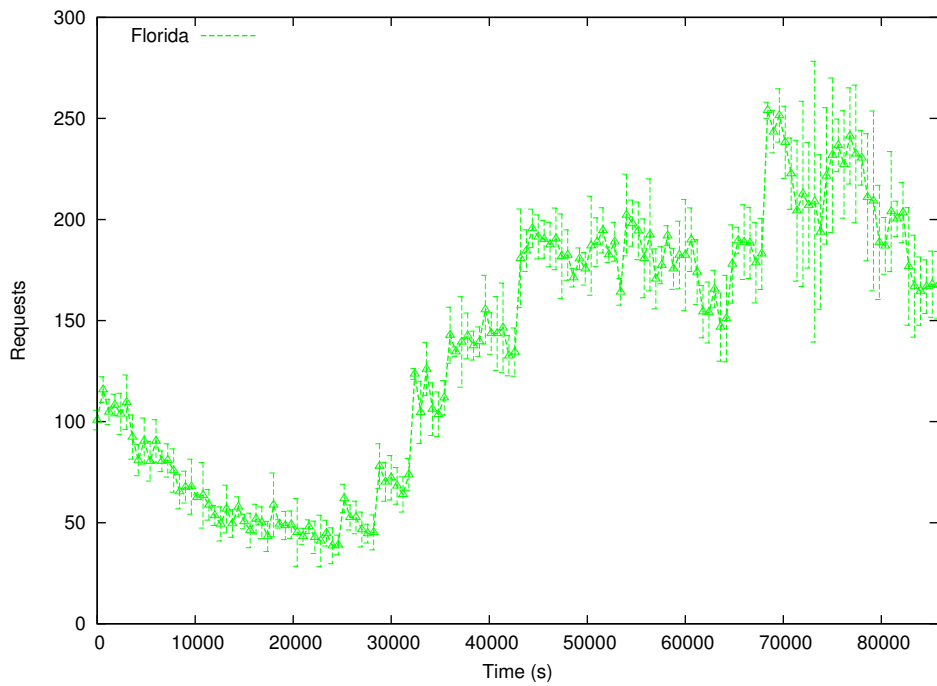

Figure A.2: Requests serviced at Florida by ABAC.

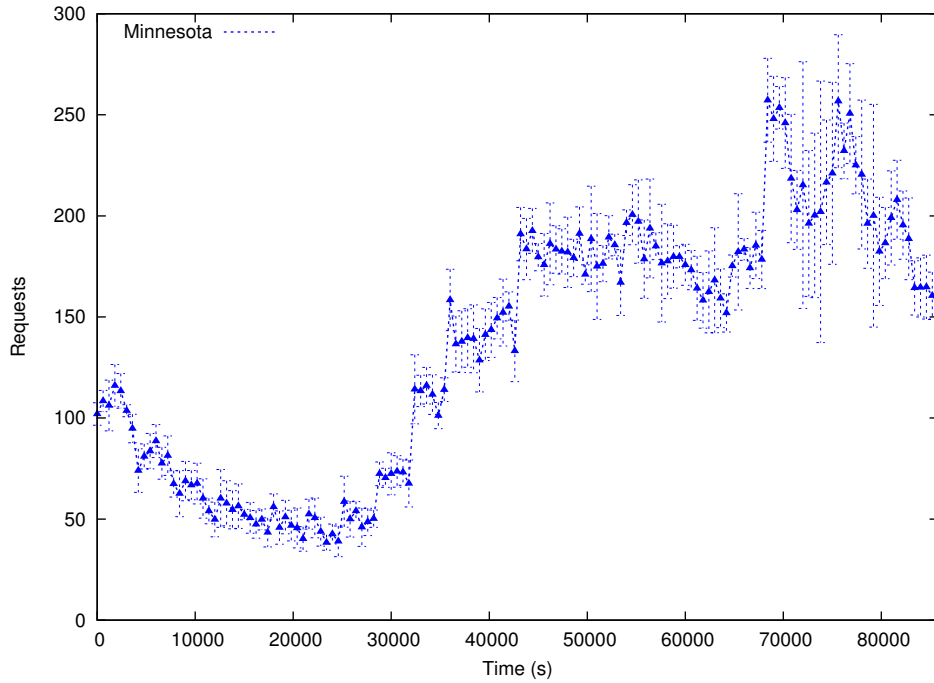

Figure A.3: Requests serviced at Minnesota by ABAC.

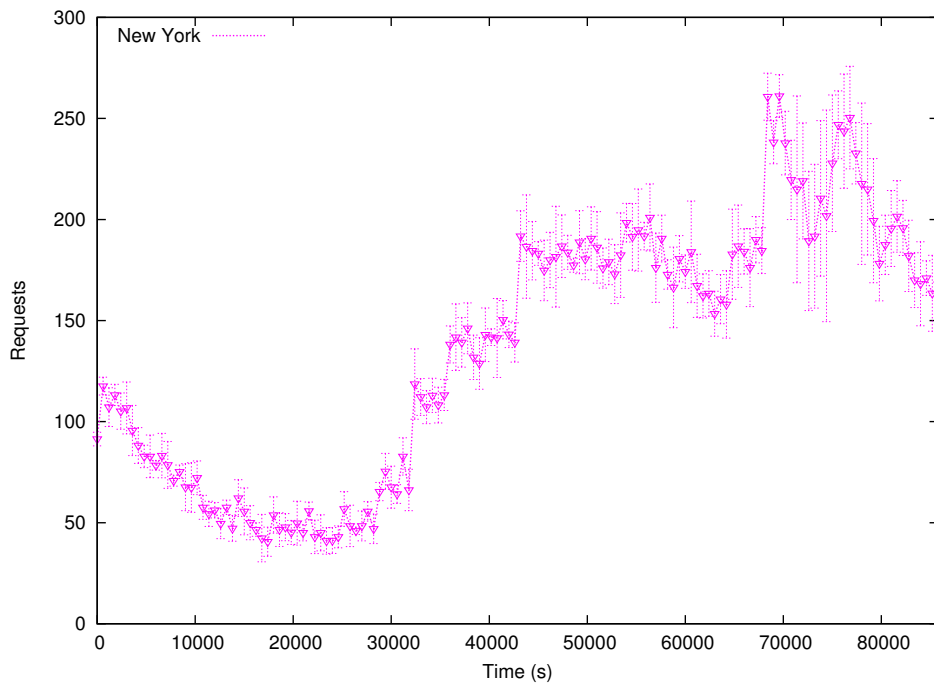

Figure A.4: Requests serviced at New York by ABAC.

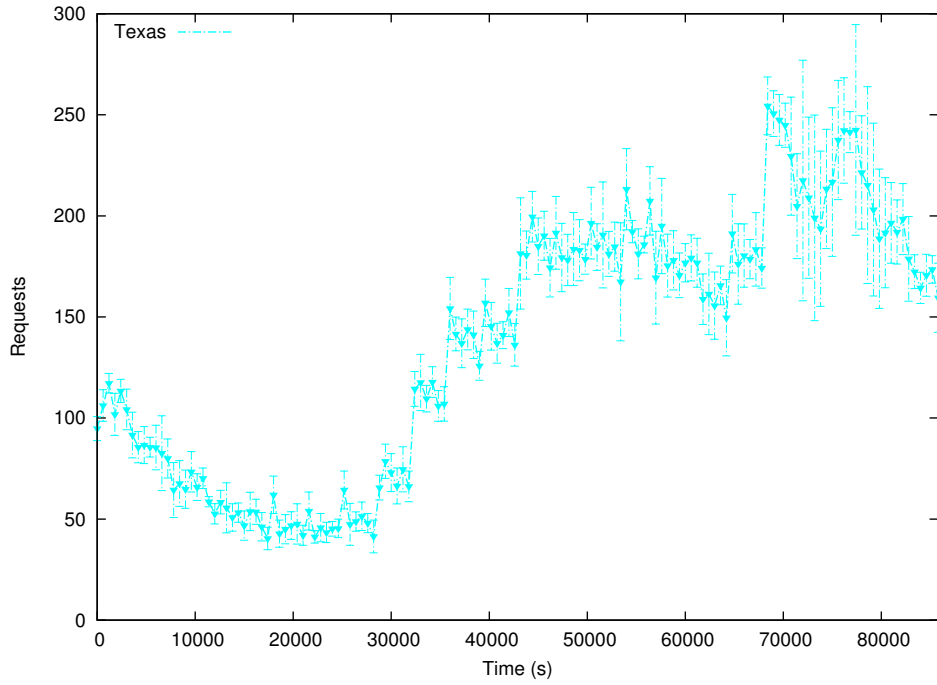

Figure A.5: Requests serviced at Texas by ABAC.

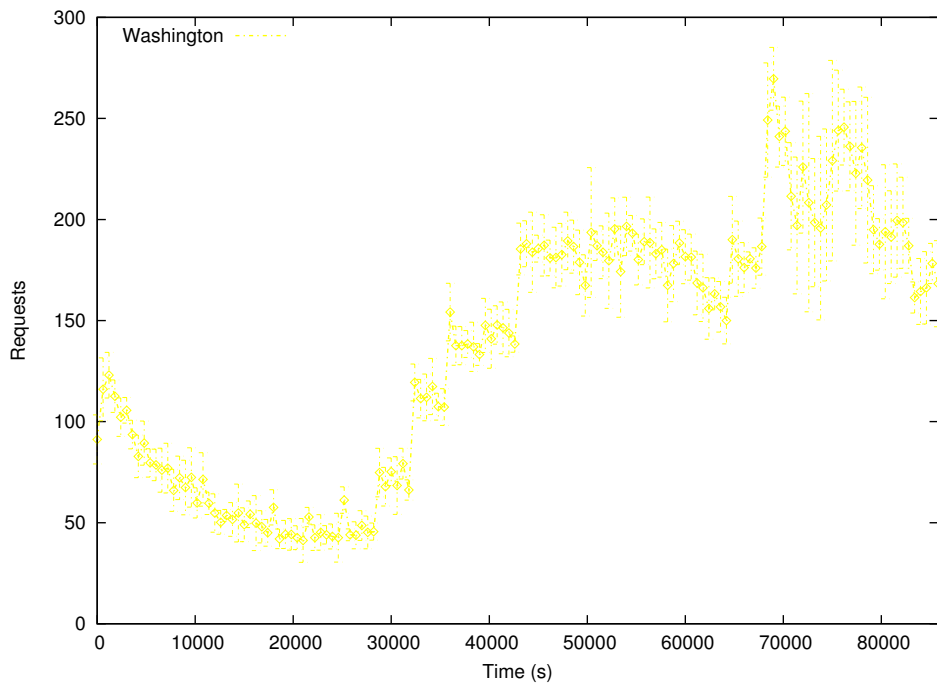

Figure A.6: Requests serviced at Washington by ABAC.