

Advances in Materials and Processing Technologies

The Effect of Metal Additive Manufacturing Powder Recycling on Part Characteristics and Powder Reusability

--Manuscript Draft--

| | |
|---------------------------|---|
| Full Title: | The Effect of Metal Additive Manufacturing Powder Recycling on Part Characteristics and Powder Reusability |
| Manuscript Number: | |
| Article Type: | Research Article |
| Keywords: | Additive Manufacturing; Direct Metal Laser Sintering; Powder Bed Fusion; Metal Powder Recycling; Powder Characteristics |
| Abstract: | <p>Direct metal laser sintering (DMLS) is a powder bed fusion (PBF) process commonly used within the medical device and aerospace industries to fabricate high value, complex components. Powder material used in the DMLS process can be costly and it is rare for a single build to require a full batch of powder. The un-melted powder, which differs in particle size and morphology from virgin powder, is often recycled for further builds. This work presents a study of the effects that recycling a stainless steel metal powder used in the DMLS process has on finished parts. Hence in this paper, powder material characteristics, such as particle size, particle morphology and bulk chemical composition have been monitored throughout the recycling process. An analysis of parts manufactured via DMLS on an EOS M280 demonstrate the negative effect of powder recycling on part quality in terms of surface roughness, part density, hardness and dimensional accuracy. Results from this research provides an insight to the effect that recycling AM powders has on the powder characteristics and on the quality of the parts produced.</p> |
| Order of Authors: | <p>P Quinn</p> <p>S. O'Halloran</p> <p>J. Lawlor</p> <p>R. Raghavendra</p> |

The Effect of Metal Additive Manufacturing Powder Recycling on Part Characteristics and Powder Reusability

P. Quinn ^{a,b*}, S. O Halloran ^{a,b}, J. Lawlor ^a, R. Raghavendra ^{a,b}

^a *Department of Engineering Technology, Waterford Institute of Technology, Waterford, Ireland, X91 K0EK*; ^b*SEAM Research Centre, Waterford Institute of Technology, Waterford, Ireland, X91 TX03*

paul.quinn@postgrad.wit.ie *corresponding author

1
2
3
4
5
6
7
8
9
10
11
12
13
14
15
16
17
18
19
20
21
22
23
24
25
26
27
28
29
30
31
32
33
34
35
36
37
38
39
40
41
42
43
44
45
46
47
48
49
50
51
52
53
54
55
56
57
58
59
60
61
62
63
64
65

The Effect of Metal Additive Manufacturing Powder Recycling on Part Characteristics and Powder Reusability

Direct metal laser sintering (DMLS) is a powder bed fusion (PBF) process commonly used within the medical device and aerospace industries to fabricate high value, complex components. Powder material used in the DMLS process can be costly and it is rare for a single build to require a full batch of powder. The un-melted powder, which differs in particle size and morphology from virgin powder, is often recycled for further builds. This work presents a study of the effects that recycling a stainless steel metal powder used in the DMLS process has on finished parts. Hence in this paper, powder material characteristics, such as particle size, particle morphology and bulk chemical composition have been monitored throughout the recycling process. An analysis of parts manufactured via DMLS on an EOS M280 demonstrate the negative effect of powder recycling on part quality in terms of surface roughness, part density, hardness and dimensional accuracy. Results from this research provides an insight to the effect that recycling AM powders has on the powder characteristics and on the quality of the parts produced.

Keywords: Additive Manufacturing, Direct Metal Laser Sintering, Powder Bed Fusion, Metal Powder Recycling, Powder Characteristics

Introduction

Additive manufacturing (AM) allows for complex, high value parts to be produced for a range of industries including the aerospace, medical and automotive industries [1].

EOS 316L stainless steel is a commonly used stainless steel powder within AM for these applications allowing for the production of highly corrosion resistant parts [2].

The additive manufacturing process in this research is Direct Metal Laser Sintering (DMLS), which selectively melts a metallic powder material layer-by-layer to build the final metal part. This powder material consists of spherical particles with a mean particle size distribution typically between 10 and 80 μm in diameter. The metal powders used within the PBF processes can be costly and to fully utilise a batch of

1 metal powder, recycling the un-melted powder is beneficial. Recycling of powder
2 consists of sieving the un-melted powder and reusing this sieved powder for subsequent
3 builds. However, this recycling process leads to changes in the characteristics of the
4 powder material due to exposure to the building process multiple times.
5
6

7
8
9 It is well understood that the characteristics of the powder material affects the
10 resulting qualities of the parts produced [1]; however, the impact of powder recycling is
11 an issue that has received little attention to date [3]. The methodology presented here
12 allows the powder characteristics to be monitored throughout the powder recycling
13 process as well as monitoring the resulting part qualities. At present this practice of
14 recycling metal powders for AM varies in industry, as corresponding standards for
15 powder material in AM are currently only at development stage [4]. The chemical
16 composition of the powder affects the resulting microstructure of the part; therefore,
17 changes in the chemical composition due to the recycling process will lead to change in
18 the part microstructure produced [5]. Previous research [6] has found that with
19 increased powder recycling, the powder particles become larger in size and less
20 spherical in shape. These characteristics affect layer homogeneity as the powder is
21 distributed across the build plate. This in turn affects the melting process [7] and the
22 resulting quality of the parts built [3]. The distribution of particles has been found to
23 affect the as built density and surface roughness of the parts the presence of more coarse
24 particles in the powder leads to a rougher surface and parts with a lower density [8].
25
26
27
28
29
30
31
32
33
34
35
36
37
38
39
40
41
42
43
44
45
46
47

48 The results presented in this paper provide an insight into the effect of powder
49 recycling on the powder characteristics and the resulting part qualities, thus allowing for
50 a greater utilisation of powder material for the AM process.
51
52
53
54
55
56

57 **Methods and Materials**

58
59

60 The powder material, EOS 316L Stainless Steel, was assessed after each build, with a
61
62
63
64
65

1 sample taken after the sieving process. The characteristics of the sampled powder as
2 outlined in Table 1 were then assessed by the corresponding test methods. The
3 characteristics of the powder sampled after sieving have been assessed for this study, as
4 this is the material used for subsequent builds.
5
6
7

8
9 The un-melted powder particles were sieved after each build using a 63 μm
10 meshed sieve to ensure that any contaminants, in particular, any oversized or partially-
11 melted particles are not introduced into the powder batch. This sieved powder was then
12 used for the next build. This cycle was repeated for a total of seven builds resulting in a
13 total of 88 hours of accumulated build time on the powder.
14
15
16
17
18
19
20

21 As shown in Table 1, the chemical composition of the powder was determined
22 through the use of SEM and EDX analysis using a Hitachi TM3030Plus Tabletop
23 Microscope. To carry out this analysis, a sample of powder was mounted in epoxy resin
24 and then micro-sectioned and polished before being placed in the SEM and an EDX
25 map was then conducted to determine the composition of the powder. The recorded
26 composition was then compared to the specified composition as per the powder
27 manufacturers datasheet [2].
28
29
30
31
32
33
34
35
36
37

38 The particle size was assessed and monitored at each recycling stage of the
39 process using a Microtrac Series 3500 laser diffraction particle size analyser. This
40 process disperses a sample of powder in front of a tri-laser light source, and the
41 resulting diffraction pattern measures the particle size of each powder particle. The
42 mean particle size and particle size distribution was recorded for three samples of
43 powder and averaged.
44
45
46
47
48
49
50
51

52 The morphology of the powder particles was also assessed at each recycling
53 stage through SEM imaging (x500 magnification) and image analysis using the ImageJ
54 software. The circularity, C , of the particles was assessed using Equation (1).
55
56
57
58
59
60
61
62
63
64
65

$$C = 4\pi\left(\frac{A}{P^2}\right) \quad (1)$$

Where A is the area of the particle and P is the perimeter of the particle. A circularity value of 1 depicts a perfectly circular particle [9].

To assess the impact of the powder characteristics on the resulting as built part qualities a series of parts were designed and printed on an EOS M280 DMLS machine using the default EOS parameters, in 20 μm layers. The parts, included three density cubes, an overhang part and a geometry block, as shown in Figure 1; these allowed for the tests outlined in Table 2 to be carried out.

The dimensional accuracy of all the printed parts was determined using a CNC coordinate measuring machine, OGP Smartscope CNC 500, with a dimensional resolution of 0.5 μm . Built parts were measured prior to removal from the build plate. Measurements were repeated five times and averaged; the averaged maximum difference from the designed dimensions was recorded.

Hardness of the built parts was tested using a 1/16" ball indenter with a 100kgf applied on a Rockwell Hardness tester on the HRB scale. Part hardness was measured on the top surface as well as the side surface of the geometry block. Measurements were repeated five times and averaged for each surface.

Surface roughness for the overhanging surfaces of the overhang part was measured using Bruker Contour GT-K (vertical resolution ~ 0.1 nm) white light interferometry (WLI). This method allows for a non-contact measurement of the arithmetic mean, Ra , of the surface profile. Five measurements of each overhanging surface was taken and averaged, allowing for a greater representation of the overall surface roughness.

Part density of the as built components was monitored using micro-sectioning of the three density cubes, the three cubes were sectioned in different orientations.

1 Micrographs, using a Keyence digital microscope VH-Z 100R at x500 magnification, of
2 the sections of the cubes allowed for the internal pores to be identified and thus, the
3
4 resulting part density calculated through image manipulation using the ImageJ software.
5
6

7 8 **Results and Discussion** 9

10 11 *Effect of Recycling on Powder Characteristics* 12

13
14 The bulk powder chemical composition primarily consists of Iron (Fe), Chromium (Cr),
15 Nickel (Ni) and Molybdenum (Mo) with smaller quantities of other elements present
16
17 [2]. Throughout the multiple recycling stages the EDX map results showed no
18
19 significant change in the powder composition with the repeated use of the powder.
20
21
22

23
24 Powder particle size affects how the powder material is layered and melted. In
25
26 general, a distribution of larger and smaller particles is required to maintain consistent
27
28 layering and melting during the build process. The effect of powder recycling, in terms
29
30 of accumulated build time, on the mean powder particle size is shown in Figure 2 (each
31
32 data point on the graph represented a recycling stage). An increase in the mean particle
33
34 size is observed as the build time increases. This is due to the ease that smaller particles
35
36 are melted in the build process, often being melted first causing the larger particles to be
37
38 recycled for future builds.
39
40
41
42

43
44 Powder morphology was measured using Equation (1) as described above. The
45
46 morphology of individual particles affects the way in which the powder flows. The less
47
48 circular the particle, the more difficult it will be to flow, thus, affecting the consistency
49
50 and repeatability of the layering process. The effect of powder recycling, in terms of
51
52 accumulated build time, on powder morphology, i.e. circularity, is presented in Figure
53
54 3. A decrease in the powder circularity is observed as powder is recycled and the
55
56 accumulated build time increases. Particles are less circular compared to the virgin
57
58
59
60
61
62
63
64
65

1 powder due to the inclusion of particles which contain agglomerates as a result of
2 partial melting of adjacent particles in the build process. Figure 4 provides examples of
3 particles with agglomerates and partially melted particles observed at various powder
4 recycling stages.
5
6
7
8
9

10 ***Effect of Powder Recycling on Manufactured Part Quality***

11 Analysis of the parts, shown in Figure 1, was carried out after each build as per the
12 methods detailed in Table 2. Dimensional accuracy of the parts produced was assessed
13 and the maximum difference, in mm, from the designed dimension was observed. The
14 effect of the accumulated build time on the dimensional accuracy, i.e. the maximum
15 difference from the designed dimensions, is show in Figure 5. The result shows that as
16 the accumulated build hours increase due to powder recycling the maximum difference
17 from the designed dimensions also increases.
18
19
20
21
22
23
24
25
26
27
28
29
30

31 The part hardness for 316L built components is specified in the manufacturers
32 data sheet as 89 HRB [2]. The measured part hardness remained within $\pm 5\%$ of this
33 specified hardness from the data sheet regardless of the recycling stage.
34
35
36
37

38 Surface roughness for as built parts using 316L powder is $13 \pm 5 \mu\text{m}$, as stated
39 in the manufacturers data sheet [2]. The effect of accumulated build time due to powder
40 recycling on the surface roughness of the manufactured overhang part is presented in
41 Figure 6. The surface roughness, R_a , increases with the increase in the number of
42 powder recycling stages. The last 3 data points are located outside the manufacturer's
43 stated surface roughness.
44
45
46
47
48
49
50
51
52

53 Part density for as built 316L parts is 100%, as stated in the powder
54 manufacturer data sheet [2]. The effect of accumulated build time (powder recycling) on
55 as built part density is presented in Figure 7. The results show as the accumulated build
56 time increases, due to multiple powder reuses, the as built part density decreases.
57
58
59
60
61
62
63
64
65

Influence of powder characteristics on the part qualities

1
2
3 Relating the changes in the powder characteristics to the resulting part qualities allows
4
5 for a greater understanding of how the powder affects the built parts. The analysis
6
7 presented here investigates the effect of the increasing particle size on the part density
8
9 as well as showing the effect of the decreasing circularity of particles on the as built
10
11 surface roughness, as shown in Figure 8.
12
13

14
15 Figure 8 shows that the change in the part qualities, specifically, part density and
16
17 surface roughness can be attributed to changes in the powder characteristics, such as
18
19 powder size and morphology. Often, part density and surface roughness are critical part
20
21 qualities required by designers, particularly in industries such as medical device and
22
23 aerospace. Therefore, the influence of raw material properties on the resultant part
24
25 characteristics are important for the manufacturing of high quality parts. Figure 8(a)
26
27 shows that as the mean particle size increases the part density decreases. This is
28
29 attributed to the change in the powder layering process due to differences in the mean
30
31 particle sizes. Figure 9 depicts the layering process of powder in the build plate for (a)
32
33 virgin material with more fine particles present and (b) recycled powder showing that
34
35 with the larger mean particle size and fewer small particles, voids and pores are
36
37 presented in the powder layer due to the unevenness of the layering process; this in turn
38
39 results in voids and powder in the as built part.
40
41
42
43
44
45

46
47 Surface roughness is often a critical feature of a manufactured part due to the
48
49 relationship between surface roughness and component performance and also due to
50
51 difficulty in post-processing some features to produce the desired surface finish [10].
52
53 Figure 8(b) shows that the decreasing circularity of the particles leads to an increase in
54
55 the surface roughness of the overhanging surface. This is a combination of both the
56
57 larger and less circular particles being present for the melting of the surface of the
58
59
60
61
62
63
64
65

1 overhang part. The larger and less circular particles remain partially melted to the
2 surface producing the rougher surface. Figure 10 shows the changing powder
3 characteristics (SEM images at top in Figure 10 showing particle size and morphology)
4 and the increasing surface roughness (WLI images at bottom of Figure 10) at various
5 stages (0, 16.75 and 88 accumulated build hours) in the recycling process.
6
7
8
9
10
11
12

13 **Conclusions**

14
15
16 The results from this research show that the continued recycling of powder material has
17 an effect on the powder characteristics and the resulting part qualities. The mean
18 particle size of the powder increases with the number of powder reuses, indicating that
19 smaller particles are being melted by the process leaving larger particles for subsequent
20 builds. The particles also become less circular, suggesting a change in morphology due
21 to the partial melting of smaller powder particles to larger particles causing
22 agglomerates to form. The results show that there was no significant change found in
23 the powder chemical composition through the recycling process.
24
25
26
27
28
29
30
31
32
33
34
35

36 The analysis of part qualities showed that the maximum difference of part
37 dimensions from the specifications increases with the increased powder use. The
38 surface roughness of the overhanging feature increased with the number of powder
39 reuses, indicating that the presence of larger particles in the powder affects the surface
40 roughness. The hardness of the parts remains consistent with the expected value. Part
41 density decreases with the number of powder reuses, indicating that an increase in mean
42 particle size produces increased porosity in the built parts.
43
44
45
46
47
48
49
50
51
52

53 These results allow for a greater understanding of the effect that powder
54 recycling has on the powder and the parts built. This will enable a more controlled use
55 of recycled powder materials as well as allowing for a higher utilisation of powder
56 batches.
57
58
59
60
61
62
63
64
65

Acknowledgements

The authors would like to thank Irish Manufacturing Research (IMR) for their funding and support of this research project.

References

- [1] A. T. Sutton, C. S. Kriewall, M. C. Leu, and J. W. Newkirk, "Powder characterisation techniques and effects of powder characteristics on part properties in powder-bed fusion processes," *Virtual Phys. Prototyp.*, 2016, vol. 12, no. 1, pp. 3–29.
- [2] EOS GmbH, "Material Data Sheet EOS StainlessSteel 316L." EOS GmHh, Munich, 2014.
- [3] J. Dawes, R. Bowerman, and R. Trepleton, "Introduction to the Additive Manufacturing Powder Metallurgy Supply Chain," *Johnson Matthey Technol. Rev.*, 2015, vol. 59, no. 3, pp. 243–256.
- [4] M. D. Monzón, Z. Ortega, A. Martínez, and F. Ortega, "Standardization in additive manufacturing: activities carried out by international organizations and projects," *Int. J. Adv. Manuf. Technol.*, 2014, vol. 76, no. 5–8, pp. 1111–1121.
- [5] M. Averyanova, P. Bertrand, and B. Verquin, "Effect of initial powder properties on final microstructure and mechanical properties of parts manufactured by selective laser melting," in *Annals of DAAAM and Proceedings of the International DAAAM Symposium*, 2010, vol. 21, no. 1, pp. 1531–1532.
- [6] J. A. Slotwinski, E. J. Garboczi, P. E. Stutzman, C. F. Ferraris, S. S. Watson, and M. A. Peltz, "Characterization of Metal Powders Used for Additive Manufacturing," *J. Res. Natl. Inst. Stand. Technol.*, 2014, vol. 119, pp. 460–493.
- [7] R. Engeli, T. Etter, S. Hövel, and K. Wegener, "Processability of different IN738LC powder batches by selective laser melting," *J. Mater. Process. Technol.*, 2016, vol. 229, pp. 484–491.
- [8] A. . Spierings, N. Herres, and G. Levy, "Influence of the particle size distribution on surface quality and mechanical properties in AM steel parts," *Rapid Prototyp. J.*, 2011, vol. 17, no. 3, pp. 195–202.
- [9] E. P. Cox, "A Method of Assigning Numerical and Percentage Values to the Degree of Roundness of Sand Grains," *J. Paleontol.*, 1927, vol. 1, no. 3, pp. 179–183.
- [10] D. Shamvedi, O. McCarthy, E. O'Donoghue, P. O'Leary, and R. Raghavendra, "Improved Performance of 3D Metal Printed Antenna through Gradual Reduction in Surface Roughness," in *2017 International Conference on Electromagnetics in Advanced Applications (ICEAA)*, 2017, vol. 6, pp. 669–672.

Table 1: Test methods for powder characterisation

Table 2: Test methods for part qualities assessment

1
2
3
4
5
6
7
8
9
10
11
12
13
14
15
16
17
18
19
20
21
22
23
24
25
26
27
28
29
30
31
32
33
34
35
36
37
38
39
40
41
42
43
44
45
46
47
48
49
50
51
52
53
54
55
56
57
58
59
60
61
62
63
64
65

1
2
3
4
5
6
7
8
9
10
11
12
13
14
15
16
17
18
19
20
21
22
23
24
25
26
27
28
29
30
31
32
33
34
35
36
37
38
39
40
41
42
43
44
45
46
47
48
49
50
51
52
53
54
55
56
57
58
59
60
61
62
63
64
65

Figure 1: Designed and printed test parts

Figure 2: Effect of powder recycling (accumulated build time) on mean particle size

Figure 3: Effect of powder recycling (accumulated build time) on powder morphology (circularity)

Figure 4: Examples of powder particles with agglomerates and partially melted particles attached

Figure 5: Effect of accumulated build time (powder recycling) on maximum difference in part dimensions

Figure 6: Effect of accumulated build time (powder recycling) on part surface roughness

Figure 7: Effect of accumulated build time (powder recycling) on as-built part density

Figure 8: Relating powder characteristics to the part qualities (a) Particle size and part density (b) Powder morphology and part surface roughness

Figure 9: Powder layering process for (a) virgin powder and (b) recycled powder

Figure 10: SEM images (top) and surface roughness plots (bottom) for (a) Virgin Powder, (b) Powder used for 16.75 hours and (c) Powder used for 88 hours

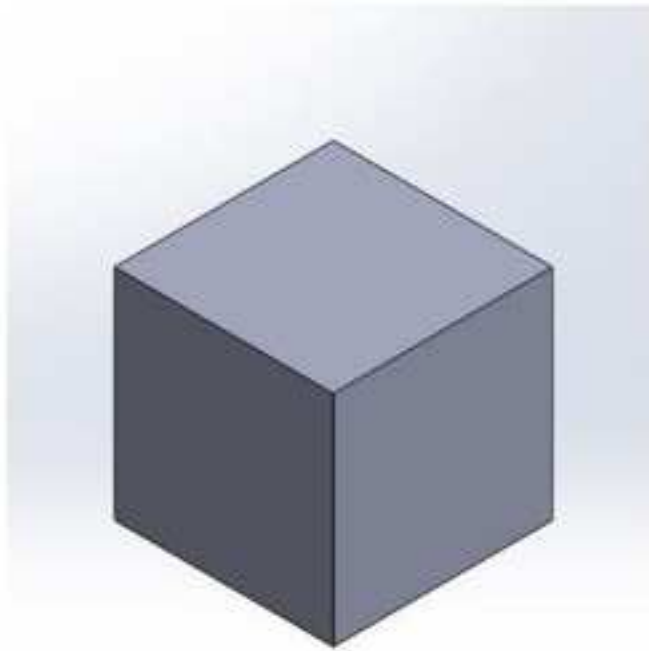

Density Cube

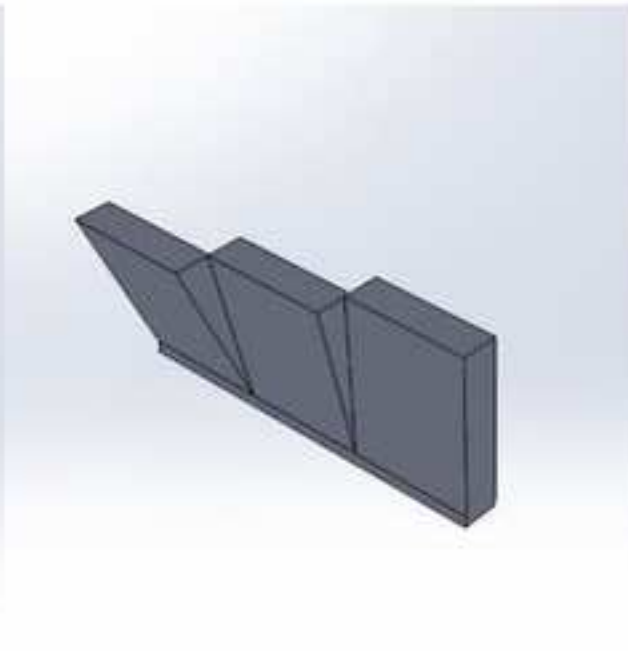

Overhang

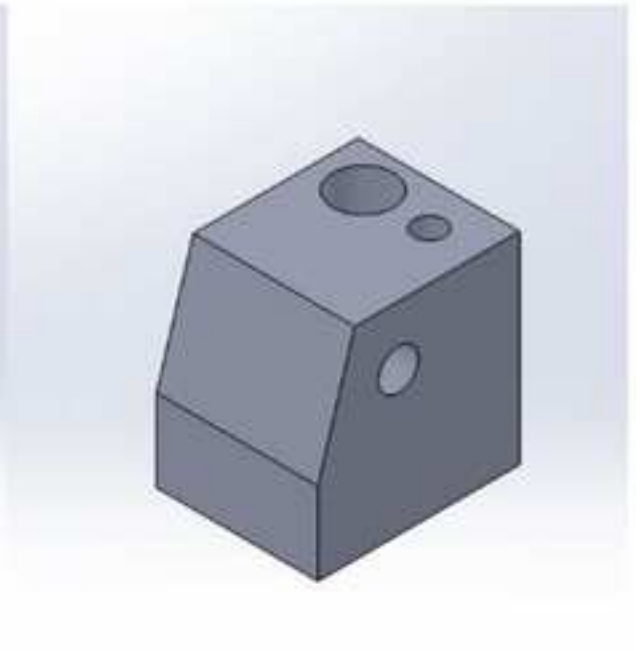

Geometry Block

Figure 2

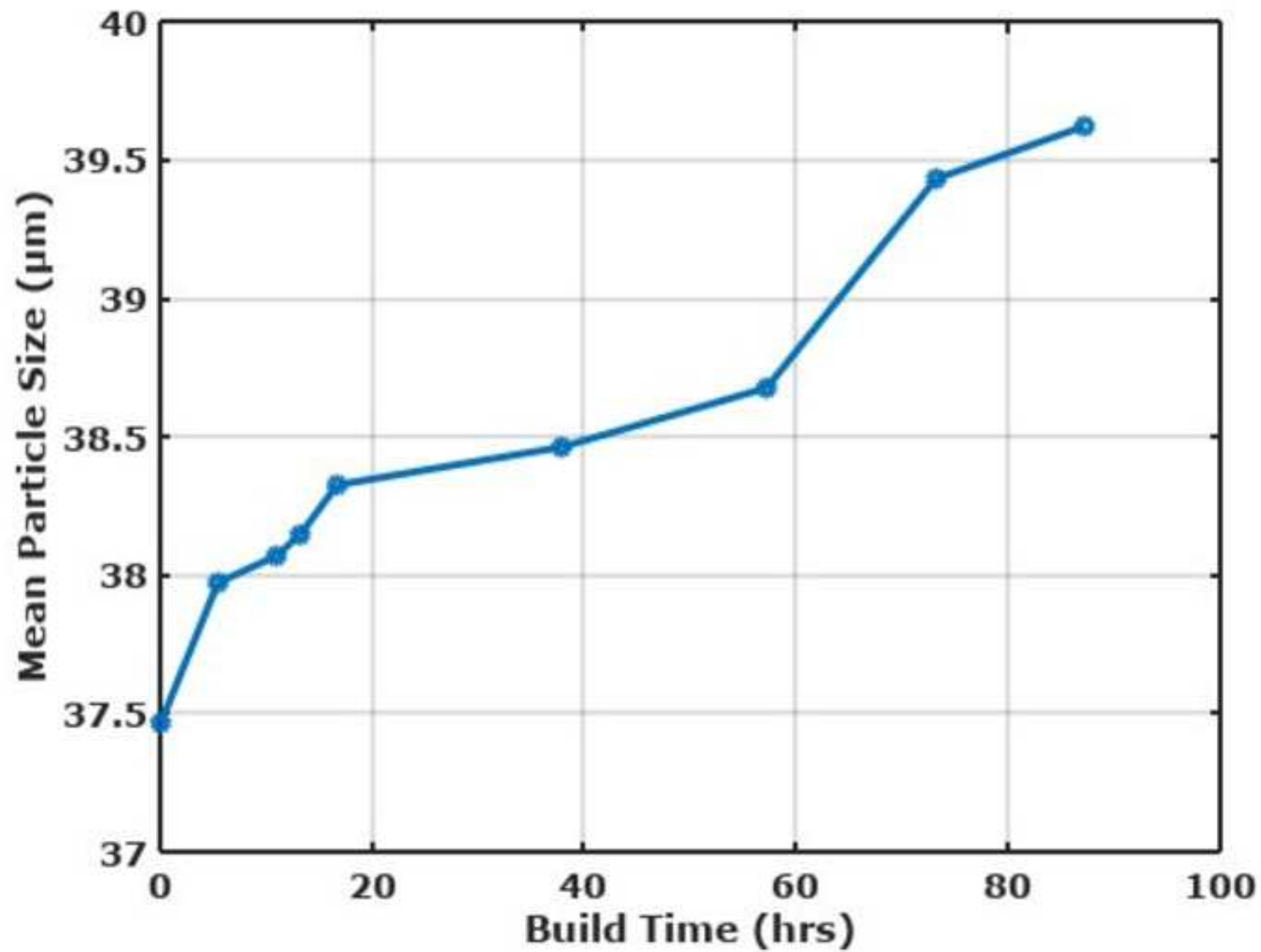

Figure 3

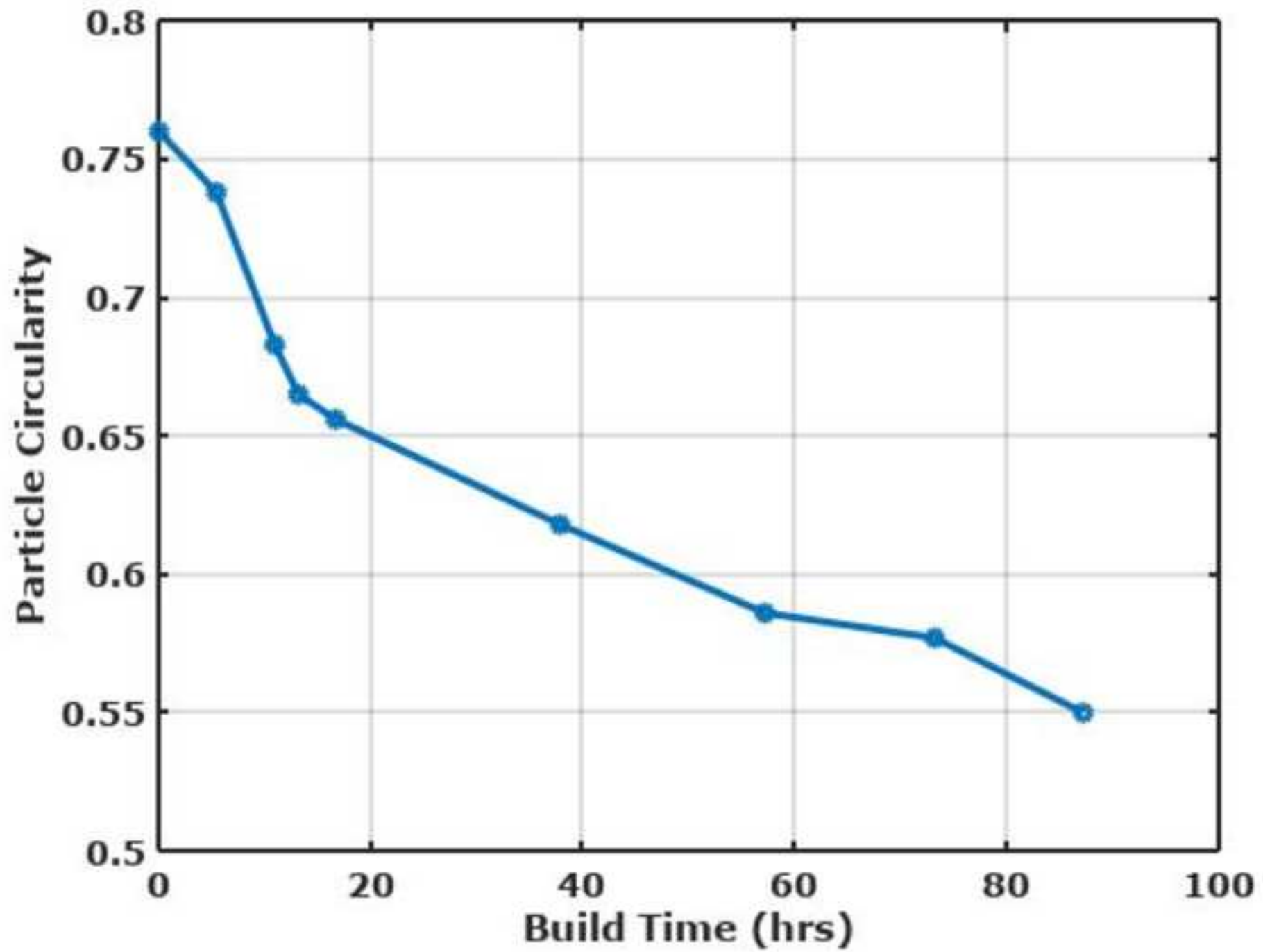
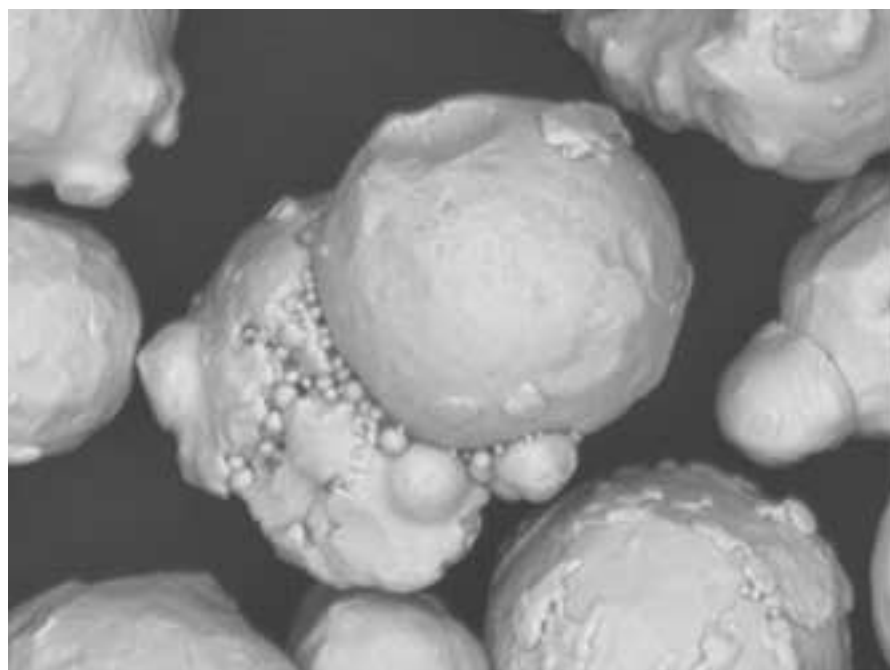
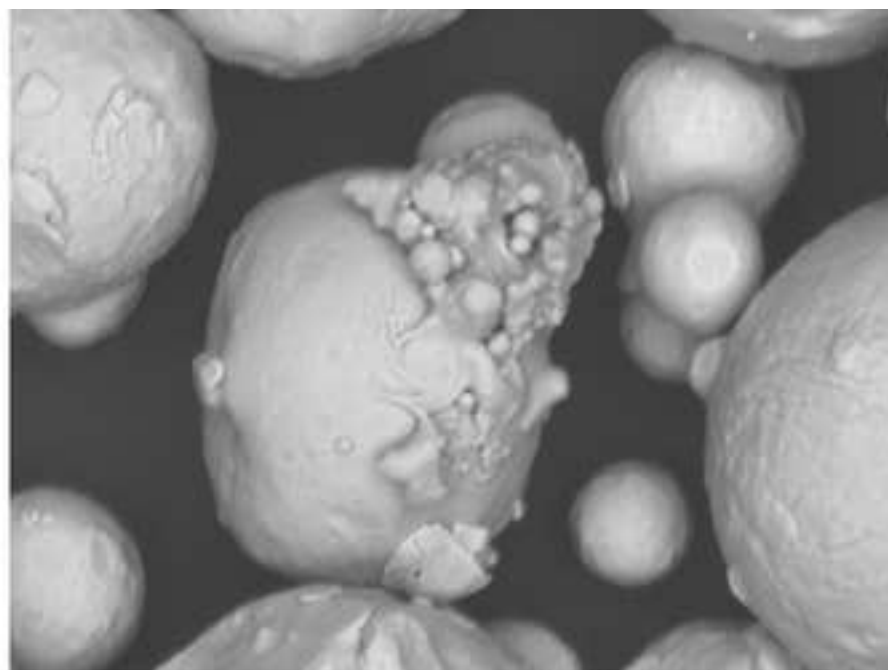

Figure 4



HM D9.6 x2.0k 30 μm



HM D9.5 x2.0k 30 μm

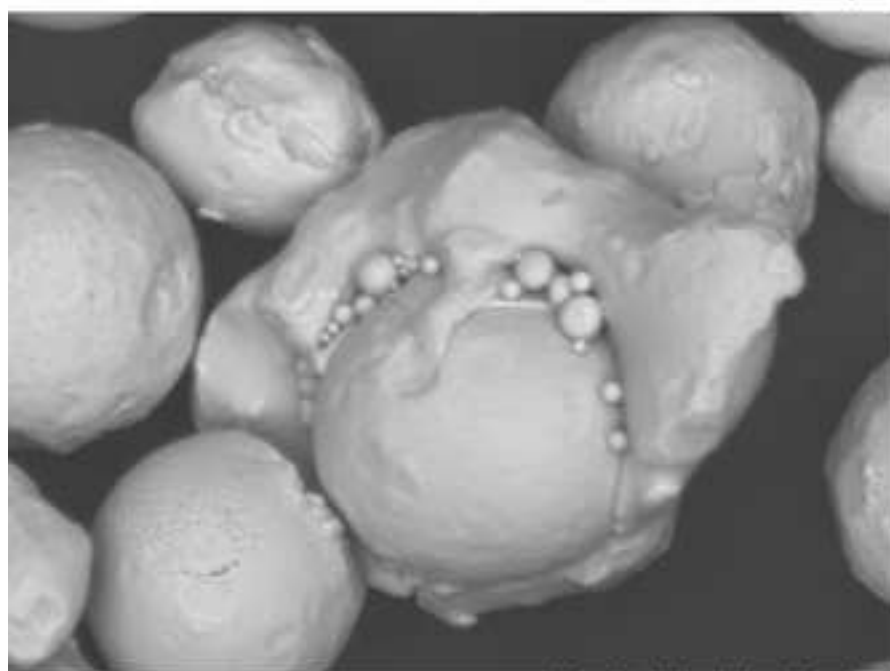

HM D9.5 x2.0k 30 μm

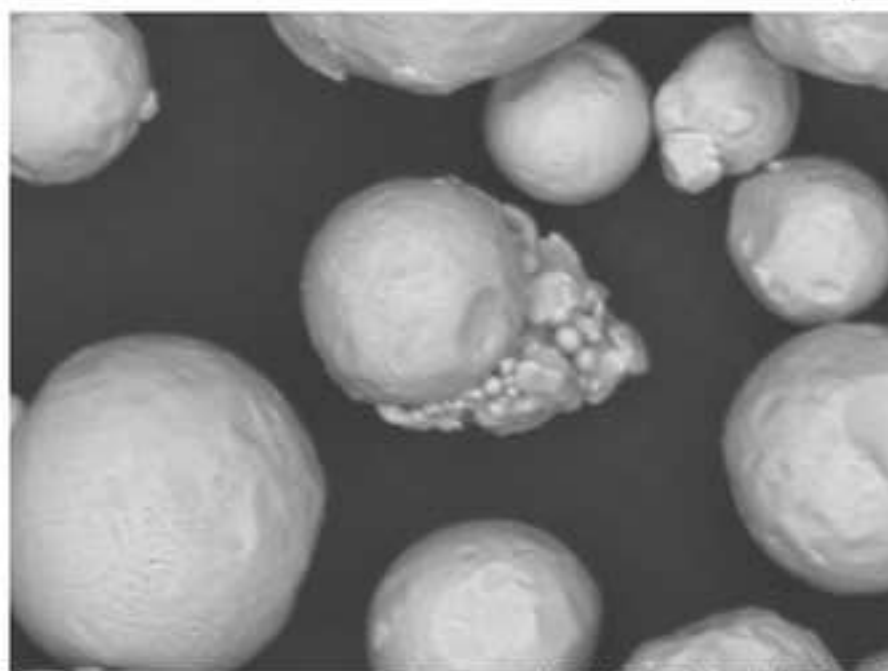

HM D9.6 x2.0k 30 μm

Figure 5

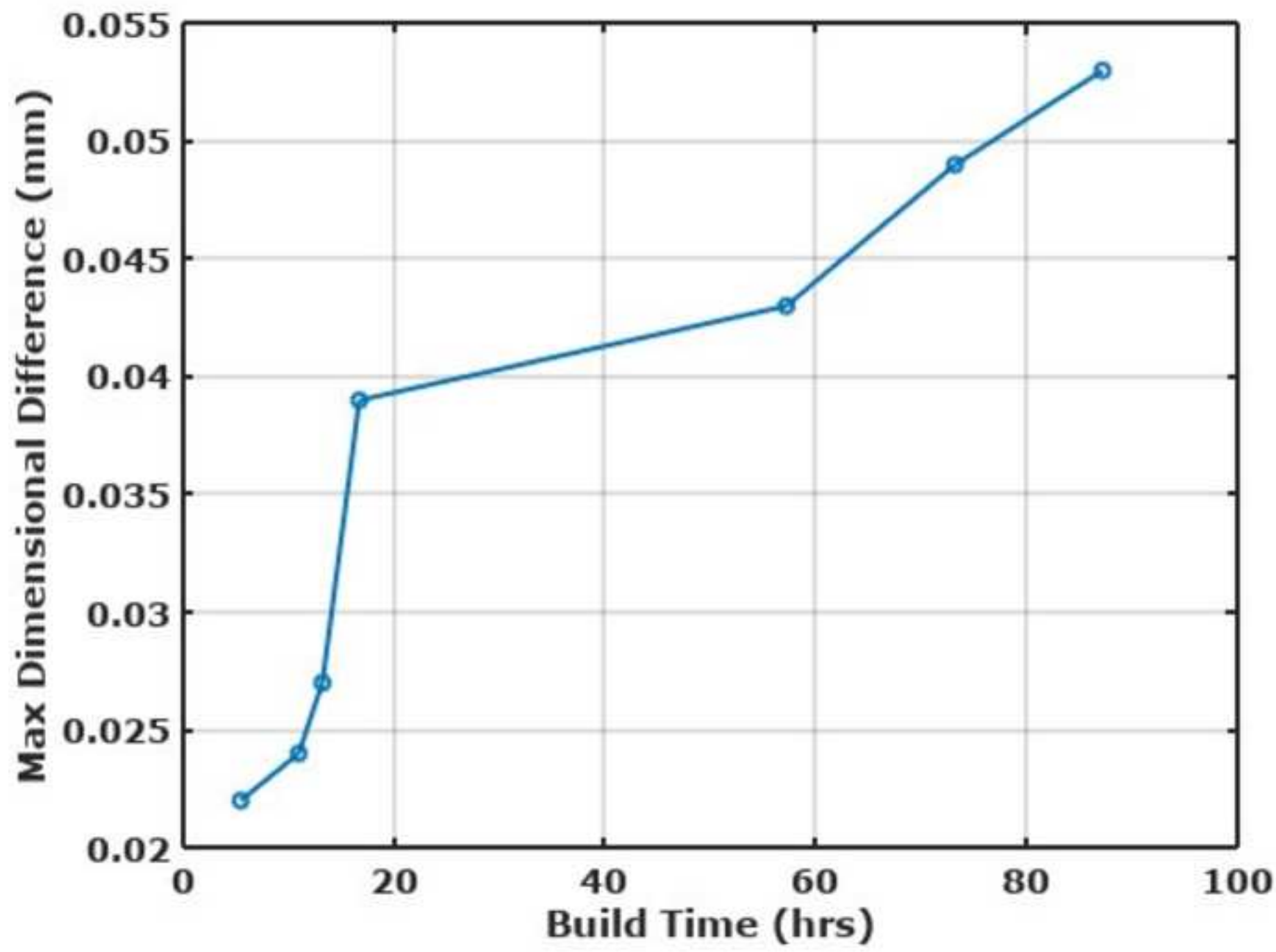

Figure 6

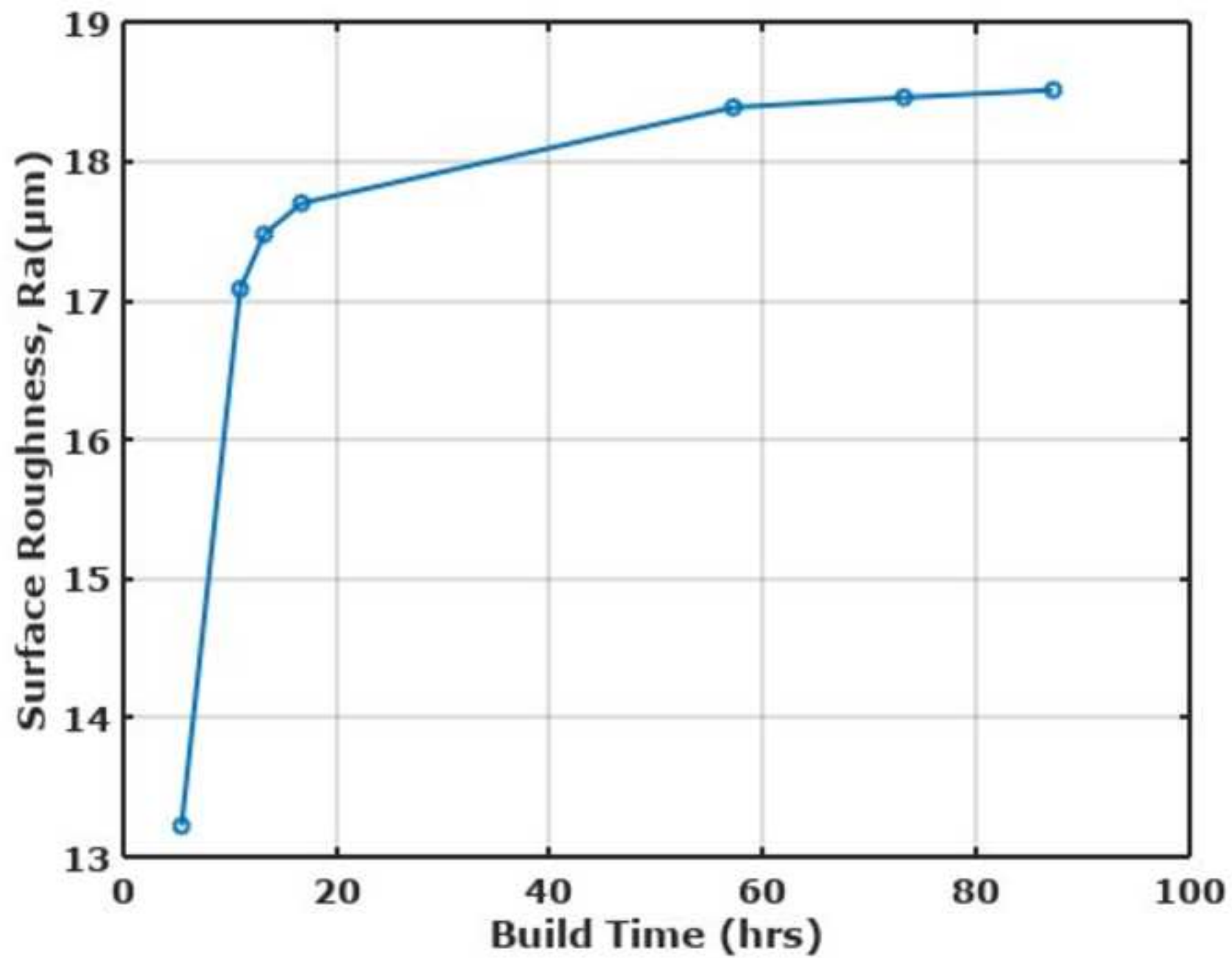

Figure 7

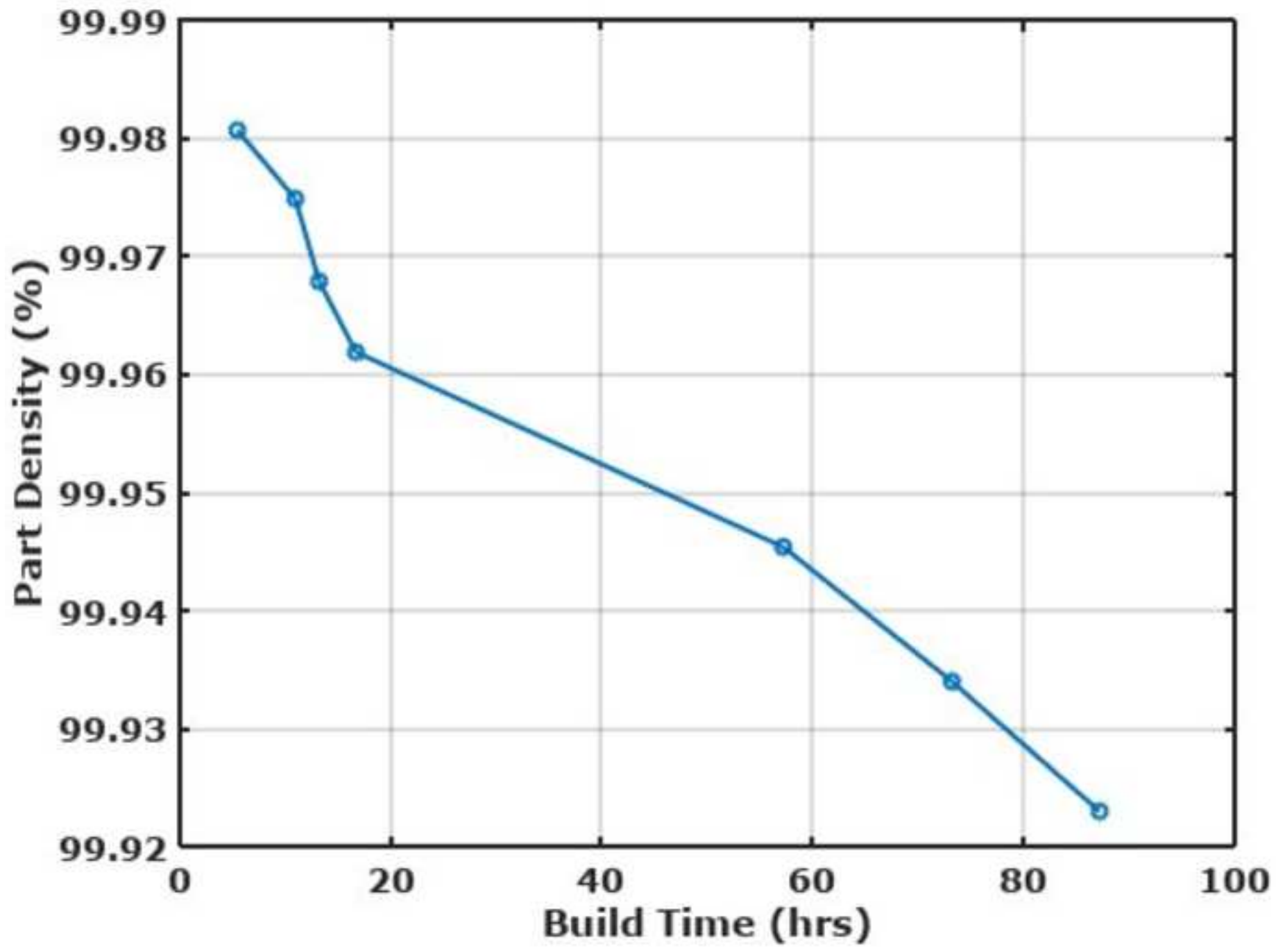
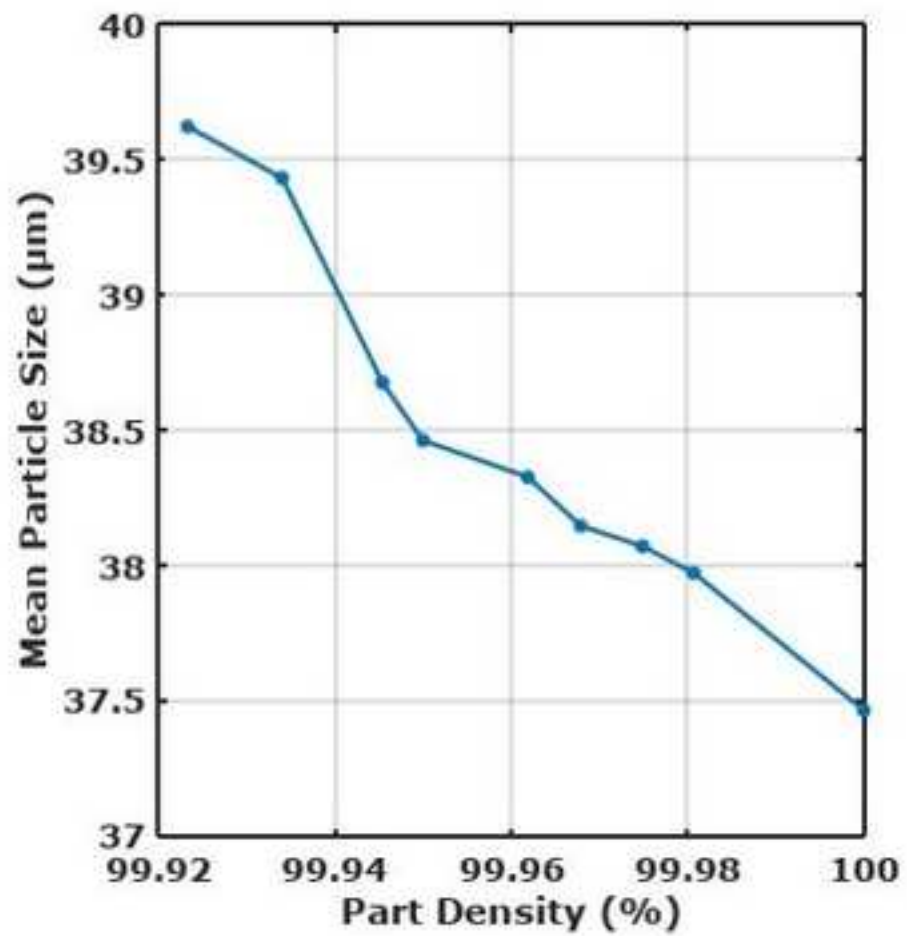
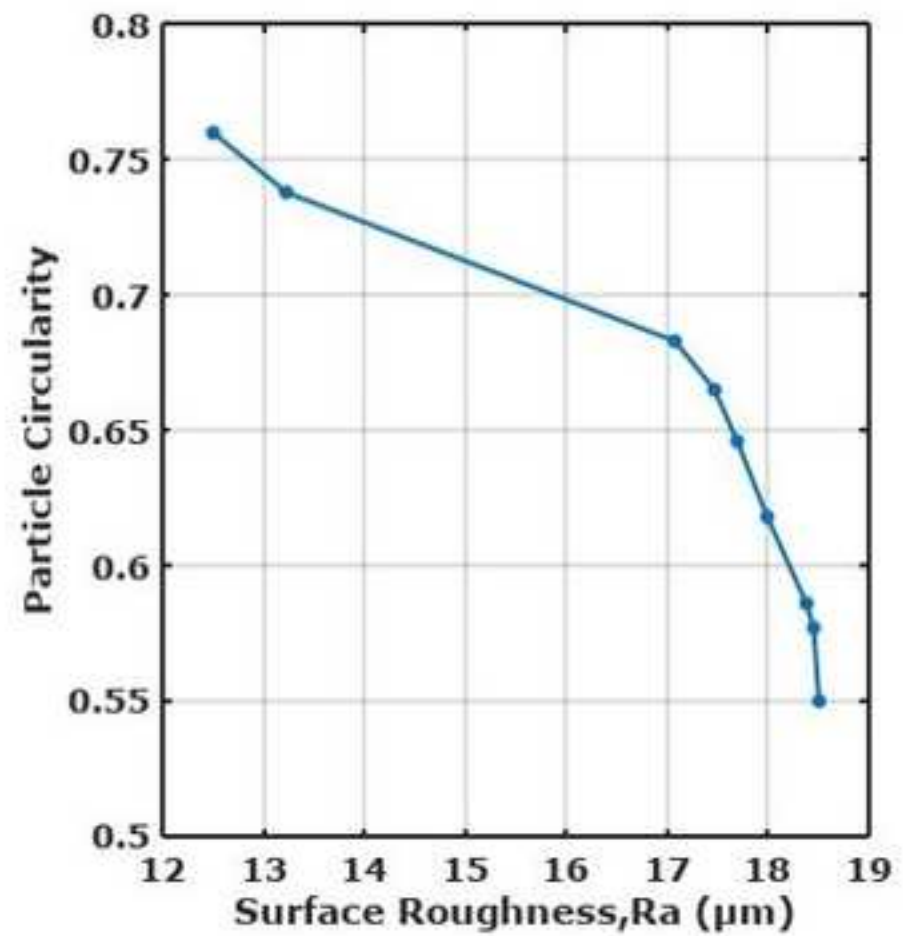

Figure 8



(a)



(b)

Figure 9

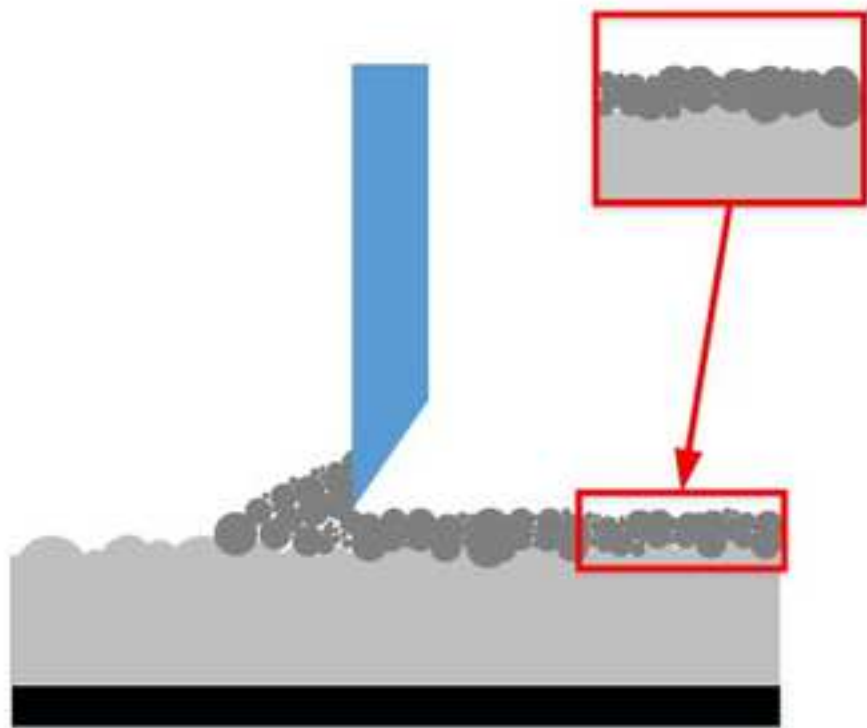

(a) Virgin Powder

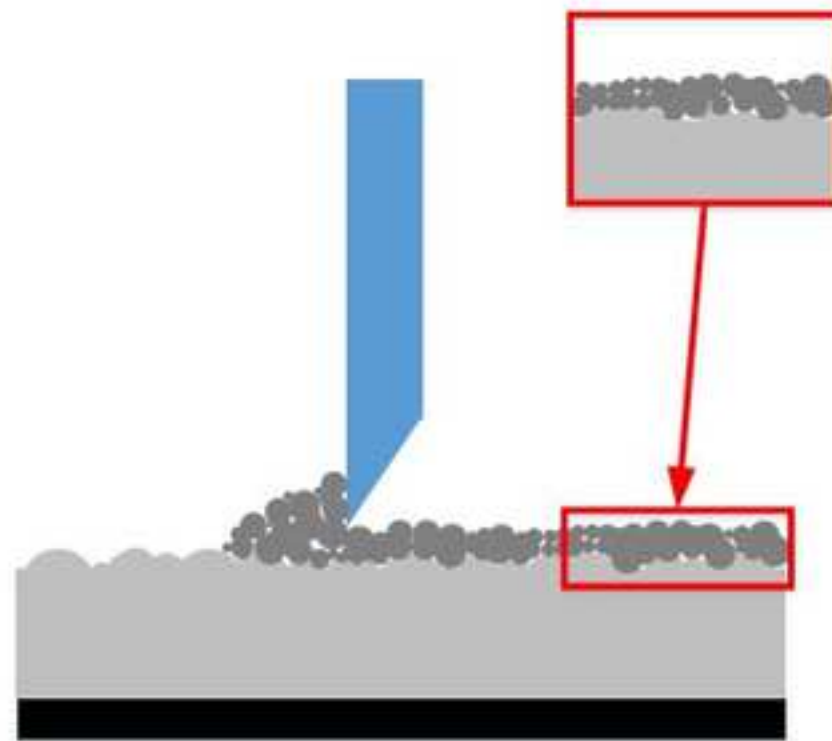

(b) Recycled Powder

Figure 10

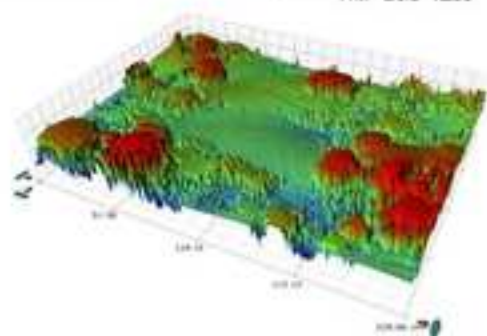
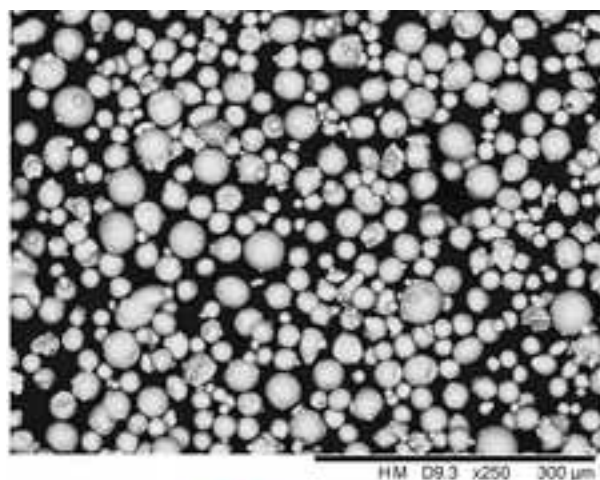

Mean Particle Size = 37.47 μm
Circularity = 0.76
Ra Value = 13.23 μm

(a) Virgin Powder

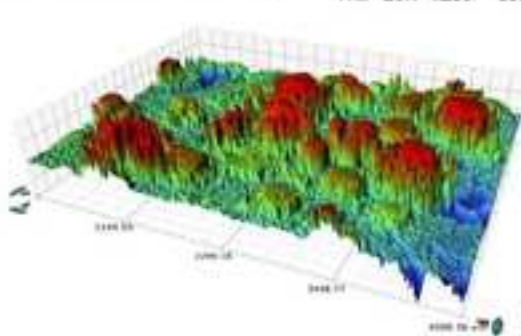
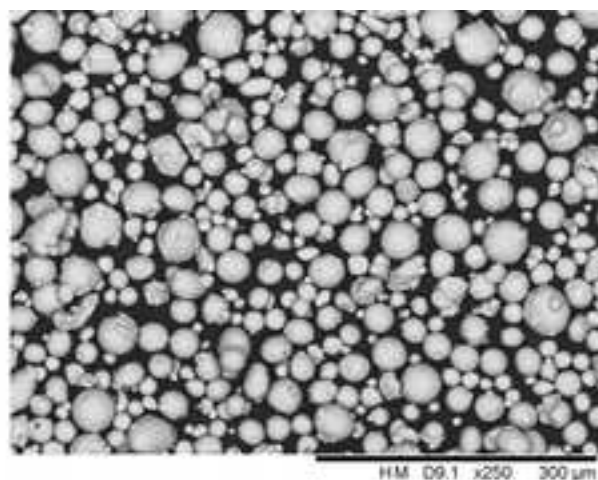

Mean Particle Size = 38.32 μm
Circularity = 0.64
Ra Value = 17.73 μm

(b) After 16.75 hours of use

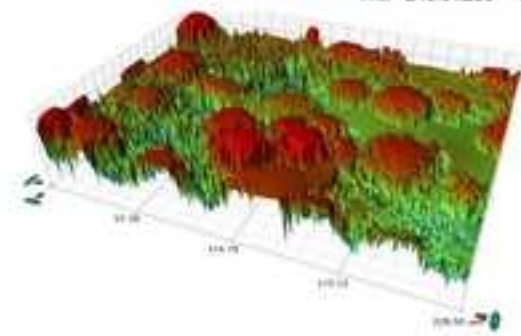
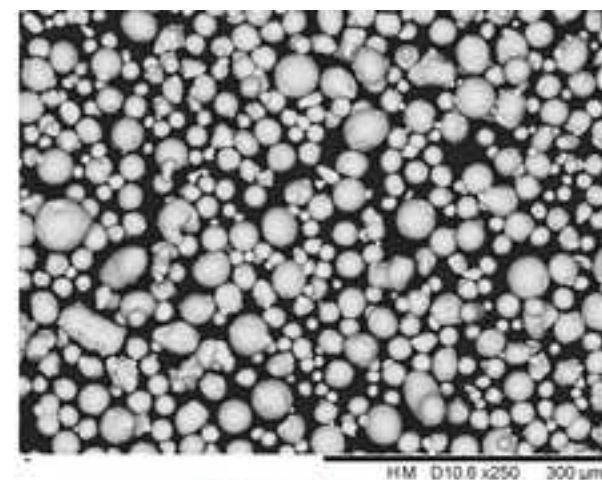

Mean Particle Size = 39.62 μm
Circularity = 0.55
Ra Value = 18.57 μm

(c) After 88 hours of use

Table 1

| Powder Characteristics | Test Method |
|------------------------------------|---|
| Powder Chemical Composition | Scanning Electron Microscopy (SEM) with Energy Dispersive X-Ray (EDX) |
| Particle Size | Dry Dispersion Laser Diffraction |
| Particle Morphology | SEM Imaging and Morphology analysis |

Table 2

| Part Quality | Test Method | Test Part |
|-----------------------------|-------------------------------------|-------------------|
| Dimensional Accuracy | CNC Coordinate Measuring Machine | All Parts |
| Hardness | Rockwell Hardness | Geometry Block |
| Surface Roughness | White Light Interferometry | Overhang |
| Part Density | Micro-sectioning and Image Analysis | 3 x Density Cubes |